



MTA, CST-100 II, SL-156 and AMP Economy Power (EP) Connectors

Table of Contents

Introduction

This catalog has been designed to assist you, our customer, identify products to satisfy your connector needs for printed circuit board headers, mass termination connectors preloaded with contacts, crimp-snap contacts and housings, and card edge connectors with preloaded contacts.

The list at right identifies by centerline the types of product available and is meant to be of assistance to you in the product selection process.



IDC
MTA-50



IDC
MTA-100



Crimp
CST-100 II



IDC
MTA-156

© 1977, 1978, 1979, 1980, 1983, 1986, 1988, 1992, 1993, 1994, 1995, 1999, 2000, 2001, 2002, 2003 and 2005 by Tyco Electronics Corporation.

All International Rights Reserved.
AMP, AMP-O-LECTRIC, AMP-O-MATIC, AMPOMATOR, CERTI-CRIMP, PRO-CRIMPER, MADISON CABLE and TYCO are trademarks.

TEFLON is a trademark of E.I. DuPont De Nemours and Company.

Other products, logos, and company names mentioned herein may be trademarks of their respective owners.

| | |
|-------------------------------------------------------------------------|--------|
| Introduction and Table of Contents | 2, 3 |
| Connector Selection Guide | 3 |
| .050 [1.27] Centerline Connectors | |
| MTA-50 IDC Connectors and Headers | 4-10 |
| Introduction and Wire-to-Board Mateability Guide | 4 |
| IDC Connector Kits (Feed-Thru and Closed End) | |
| Ribbon Cable | 5, 6 |
| Discrete Wire | 7, 8 |
| Through-Hole Header Assemblies | |
| Vertical and Right-Angle | 9 |
| Surface Mount Header Assemblies | |
| Vertical and Right-Angle | 10 |
| .100 [2.54] Centerline Connectors | |
| MTA-100 IDC Connectors and Headers | 11-31 |
| Introduction | 11 |
| Wire-to-Board Mateability Guide | 12, 13 |
| Connectors—UL94V-2 and UL94V-0 | |
| Closed End with and without Polarizing Tab | 14, 15 |
| Feed-Thru with and without Polarizing Tab | 14, 15 |
| LED Closed End and Feed-Thru—UL94V-2 | 14, 15 |
| Accessories | 16, 17 |
| Posted Connectors Mateability Guide | 18, 19 |
| MTA-100 Posted Connectors (Wire-to-Wire) UL94V-2 | |
| Closed End | 20 |
| Feed-Thru | 20 |
| Headers—UL94V-0 | |
| Flat—Straight and Right-Angle Posts | 21 |
| Narrow Flat—Straight and Right-Angle Posts | 22 |
| Polarized—Straight and Right-Angle Posts | 23 |
| Friction Lock—Straight and Right-Angle Posts | 24 |
| Headers with Retention Peg—Straight Posts | 25 |
| High Profile Headers—Right-Angle Posts | 26 |
| Polarized—High Temperature, Straight and Right-Angle Posts | 27 |
| Friction Lock—High Temperature, Straight and Right-Angle Posts | 28 |
| Polarized—Surface Mount, Straight | 29 |
| Friction Lock—Surface Mount, Straight | 29 |
| Shrouded—Straight and Right-Angle Posts | 30 |
| CST-100 II Crimp Contacts, Housings and Shrouded Headers | 31, 32 |
| .156 [3.96] Centerline Connectors | |
| MTA-156 IDC Connectors and Headers | 33-57 |
| Introduction | 33 |
| Wire-to-Board Mateability Guide | 34, 35 |
| Connectors—UL94V-2 and UL94V-0 | |
| Closed End with Locking Ramp, with and without Polarizing Tabs | 36, 37 |
| Closed End without Locking Ramp, with and without Polarizing Tabs | 36, 37 |
| Feed-Thru with Locking Ramp, with and without Polarizing Tabs | 38, 39 |
| Feed-Thru without Locking Ramp, with and without Polarizing Tabs | 38, 39 |
| Accessories | 40-42 |
| Posted Connectors Mateability Guide | 43, 44 |
| MTA-156 Posted Connectors (Wire-to-Wire)—UL94V-2 | |
| Closed End | 45 |
| Feed-Thru | 45 |
| MTA-156 Headers—UL94V-0 | |
| Flat—Straight Posts | 46 |
| Flat—Right-Angle Posts | 47 |
| Friction Lock—Straight Posts | 48 |
| Friction Lock—Right-Angle Posts | 49 |
| Polarized Lock—Straight Posts | 50 |
| Polarized Lock—Right-Angle Posts | 51 |
| Friction Lock—High Temperature, Straight Posts | 52 |
| Shrouded—Straight and Right-Angle Posts | 53 |
| MTA-156 Quad Connectors—UL94V-0 | 54, 55 |
| Closed End with Locking Ramp | 55 |
| Feed-Thru with Locking Ramp | 55 |

Table of Contents (Continued)



**Crimp
SL-156**



**Crimp
AMP EP Connectors**

Need more information?

Call Technical Support at the numbers listed below.

Technical Support is staffed with specialists well versed in Tyco Electronics products. They can provide you with:

- Technical support
- Catalogs
- Technical Documents
- Product Samples
- Authorized Distributor Locations

MTA-156 Card Edge 56, 57
 Connectors — UL94V-0
 Closed End with and without Mounting Ears 56
 Feed-Thru with and without Mounting Ears 56
 Accessories 57
SL-156 Crimp Connectors and Headers 58-62
 Wire-to-Board Mateability Guide 58
 Wire-to-Board Crimp Contacts and Keying Plugs 59
 Wire-to-Board Housings — UL94V-0 60
 Housings with Through Board Latch — UL94V-2 61
 Housings and Contacts for Large Insulation Diameter (LID) Wire 62
AMP Economy Power (EP) Connector System 63-69
 .156 [3.96] Centerline Connectors
 Introduction 63
 Crimp Contacts 64
 Plug Housings, Low-Profile 64
 Low-Profile Headers — Straight and Right-Angle Posts 65
 Low-Profile Headers, High Temp. — Straight and Right-Angle Posts 66
 .200 [5.08] Centerline Connectors
 Plug Housings and Straight and Right-Angle Post Headers 67
 .312 [7.92] Centerline Connectors
 Low-Profile Headers — Straight Posts 68
Single Connectors
 1-Position Plug Housing and High-Profile Header — Straight Post 69
MTA Wire Selection and Ribbon Cable Preparation 70
IDC Ribbon Cable 71-74
MTA Wire Termination Flowchart 75
MTA Application Tooling 76-79
Part Number Index 80-82
Global Contacts 83

Connector Selection Guide

| Product Name | Centerline | Contact Termination | Wire-to-Wire Option | No. of Positions | Wire Size (AWG) | Wire Insulation Dia. Max. | Current Rating (A)** | Voltage Rating Max. (VAC) | Operating Temp. Range (°C) | UL Flammability | Replacement Contacts | Approvals |
|----------------------------------------------------|--------------|---------------------|---------------------|-----------------------------------|-----------------|---------------------------|-------------------------------|---------------------------|----------------------------|-----------------|----------------------|---------------------------------------------------------------------------------------|
| .050" Centerline | | | | | | | | | | | | |
| MTA-50 IDC Connector Kits and Headers | .050 1.27 | IDC | Planned | 2-28 | 30-26 | .039* 0.99 | 1 | 30 | -55 to +105 | V-0 & V-2 | No |  |
| .100" Centerline | | | | | | | | | | | | |
| MTA-100 Connectors and Headers | .100 2.54 | IDC | Yes | 2-28 | 28-22 | .060* 1.52 | 5 | 250 | -55 to +105 | V-0 & V-2 | Yes |  |
| CST-100 II Contacts and Housings | .100 2.54 | Crimp | Planned | 2-28 | 26-22 | .065 1.65 | 4 | 250 | -55 to +105 | V-0 | Yes |  |
| .156" Centerline | | | | | | | | | | | | |
| MTA-156 Connectors and Headers | .156 3.96 | IDC | Yes | 2-24 | 26-18 | .095* 2.41 | 7 | 600 | -55 to +105 | V-0 & V-2 | Yes |  |
| Quad Connectors | .156 3.96 | IDC | No | 2-12 | 22-18 | .095* 2.41 | 12.5 | 600 | -55 to +105 | V-0 | Yes |  |
| SL-156 Contacts and Housings | .156 3.96 | Crimp | No | 1-24; 2-10 w/ through board latch | 24-18 | .105 2.67 | 10 | 250 | -25 to +105 | V-0 | Yes |  |
| SL-156 Large Ins. Dia. (LID) Contacts and Housings | .156 3.96 | Crimp | No | 2-24 | 24-16 | .112 2.84 | 10 | 250 | -25 to +105 | V-0 | Yes |  |
| .156", .200" and .312" Centerlines | | | | | | | | | | | | |
| AMP Economy Power (EP) Connector System | .156 3.96 | Crimp | No | 1-12 | 22-18 | .118 3.00 | 8 (1 pos.) 7.5 (2-12 Pos.) | 250 | -25 to +105 | V-0 | Yes |  |
| | .200 5.08 | Crimp | No | 2-12 | 22-18 | .118 3.00 | 7.5 (2-12 Pos.) | 250 | -25 to +105 | V-0 | Yes |  |
| | .312 7.92 | Crimp | No | 2-5 | 22-18 | .118 3.00 | 7.5 (2-5 Pos.) | 250 | -25 to +105 | V-0 | Yes |  |

* When terminated one position at a time.
 ** Current Rating is application dependent.

MTA-50 IDC Connectors and Headers

Product Facts

- 2-28 contact positions
- Connectors terminate 26, 28 and 30 AWG discrete wire or .050 [1.27] centerline ribbon cable
- Color-coded housings
- Maximum cable insulation diameter of .039 [0.99] with PVC insulation only
- IDC contacts pre-loaded in receptacle housing
- 30 V, 1 A contact rating
- Contact design allows for gold-to-gold or tin-to-tin interface
- Contacts are lubricated to prevent fretting corrosion
- Wire feed-thru capability for daisy-chain wiring or closed end for point-to-point wiring
- Connectors are polarized for proper mating
- Manual and semiautomatic application tooling
- Mating heights shown below:



- Component Recognized by Underwriters Laboratories Inc. to US and Canadian Standards, File No. E28476 C **UL** US (Connectors and Headers) File No. E53793 (Ribbon Cable)

These matrixes have been prepared to assist you in defining the correct mating halves for the MTA-50 header and connector kit combination. Where a "Y" is indicated the combination is a valid mating pair.

Note: Tyco Electronics does NOT recommend intermating connectors and headers with different contact platings.



The MTA-50 IDC Connector System is a wire-to-printed circuit board system with contacts in a staggered, single row on .050 [1.27] centerline. The design features wire feed-through capability for daisy-chain applications. Insulation displacement contacts are used to terminate a wide range of conductor sizes. Ribbon cable can also be terminated when the appropriate receptacle assembly and strain relief cover are used.

Header assemblies for board mount applications include right-angle (horizontal) and vertical mount products. These are available in

through-hole and surface mount configurations.

Typical uses of the MTA-50 IDC connectors would be in the Appliance, Commercial and Home Equipment and Security products industries.

See the following pages for related products:

- Ribbon Cable (reels), .050 [1.27] centerline (p. 71)
- Application Tooling (p. 76)
- Cable Assemblies (p. 74)

Performance Data

- Voltage Rating** — 30 VAC
- Current Rating** — 1 amp max.
- Low-Level Resistance** — 30 milliohms

Dielectric Withstanding Voltage — 500 VAC

Insulation Resistance — 1,000 megohms

Operating Temperature — -55°C to +105°C for connector only; cable rating may be lower

Technical Documents

Application Specification — 114-13072 MTA-50 Connectors

Product Specifications — 108-2113 MTA-50 Connectors

100-4703 MADISON CABLE Cable Specification (28 AWG, 7/36 Tinned copper, PVC insulation)

100-6257 MADISON CABLE Cable Specification (28 AWG, 7/36 Tinned copper, TPO insulation)

MTA-50 IDC Connector Kit / Header Mateability Guide

| Connector Kits | Headers | | | |
|----------------|---------|---------|---------|---------|
| | 1445120 | 1445121 | 1445169 | 1445172 |
| 1445341 | Y | Y | Y | Y |
| 1445344 | Y | Y | Y | Y |
| 1445347 | Y | Y | Y | Y |
| 1445350 | Y | Y | Y | Y |
| 1445353 | Y | Y | Y | Y |
| 1445356 | Y | Y | Y | Y |
| 1445359 | Y | Y | Y | Y |
| 1445362 | Y | Y | Y | Y |
| 1445365 | Y | Y | Y | Y |
| 1445368 | Y | Y | Y | Y |
| 1445371 | Y | Y | Y | Y |
| 1445374 | Y | Y | Y | Y |

Matrix for Tin Plated Part Numbers

| Connector Kits | Headers | | | |
|----------------|---------|---------|---------|---------|
| | 1445125 | 1445126 | 1445171 | 1445174 |
| 1445343 | Y | Y | Y | Y |
| 1445346 | Y | Y | Y | Y |
| 1445349 | Y | Y | Y | Y |
| 1445352 | Y | Y | Y | Y |
| 1445355 | Y | Y | Y | Y |
| 1445358 | Y | Y | Y | Y |
| 1445361 | Y | Y | Y | Y |
| 1445364 | Y | Y | Y | Y |
| 1445367 | Y | Y | Y | Y |
| 1445370 | Y | Y | Y | Y |
| 1445373 | Y | Y | Y | Y |
| 1445376 | Y | Y | Y | Y |

Matrix for .00030 [0.00076] Gold Plated Part Numbers

| Connector Kits | Headers | | | |
|----------------|---------|---------|---------|---------|
| | 1445123 | 1445124 | 1445170 | 1445173 |
| 1445342 | Y | Y | Y | Y |
| 1445345 | Y | Y | Y | Y |
| 1445348 | Y | Y | Y | Y |
| 1445351 | Y | Y | Y | Y |
| 1445354 | Y | Y | Y | Y |
| 1445357 | Y | Y | Y | Y |
| 1445360 | Y | Y | Y | Y |
| 1445363 | Y | Y | Y | Y |
| 1445366 | Y | Y | Y | Y |
| 1445369 | Y | Y | Y | Y |
| 1445372 | Y | Y | Y | Y |
| 1445375 | Y | Y | Y | Y |

Matrix for .00015 [0.00038] Gold Plated Part Numbers

MTA-50 IDC Connectors and Headers (Continued)

Feed-Thru and Closed End Connectors



Material and Finish

Housing — UL 94V-2 rated, thermo-plastic

Contacts — Phosphor bronze; .000100 [0.00254] min. tin in wire termination area, over .000050 [0.00127] min. nickel; choice on mating end: .000100 [0.00254] min. tin or .000030 [0.00076] gold or .000015 [0.00038] gold, over .000050 [0.00127] min. nickel

Color Coding by Wire Size for UL94V-0 Connectors

- 26 AWG** — Blue
- 28 AWG** — Green
- 30 AWG** — Brown

For Strain Relief Covers see page 6.
For mating Headers see pages 9 and 10.
For Mateability Guide, see matrixes on page 4.

Receptacle Assemblies — Ribbon Cable



Notes:

1. To determine connector overall length (dim. A), multiply .050 x the number of circuits and add .082. Example: .050 x 10 circuits equals 0.50 + .082 = .582 [14.78].
2. Strain relief covers shown on page 6 are required and sold as part of the Connector Kit.
3. Stranded UL Style 1061 or equivalent wire is recommended.
4. Unless otherwise stated all tolerances (except plating) to be ±.005 [±0.13].
5. Consult Product Drawing for RoHS Compliant information.

Connector Kits — Ribbon Cable

Connector Kit Ordering Information

Connector Kit consists of Receptacle Assembly and Strain Relief Cover.

Base part number prefixes and suffixes indicate the number of circuit positions, for example: Base part number 1445359

2 position = 0-1445359-2
and
28 position = 2-1445359-8

Note: Tin-plated connectors and headers in even position sizes from 2–12 and 18 are stocked parts; all other position sizes and products with gold-plated contacts are Make To Order.

Base Part Numbers

| Connector Type & Wire Size | Feed-Thru | | Closed End | |
|--------------------------------------------|-------------------------|-----------------|-------------------------|-----------------|
| | Connector Kit Part Nos. | No. of Circuits | Connector Kit Part Nos. | No. of Circuits |
| Tin Plated | | | | |
| 26 AWG 0.12–0.15 mm ² | 1445359 | 2–28 | 1445368 | 2–28 |
| 28 AWG 0.08–0.09 mm ² | 1445362 | 2–28 | 1445371 | 2–28 |
| 30 AWG 0.05–0.06 mm ² | 1445365 | 2–28 | 1445374 | 2–28 |
| .000030 [0.00076] Gold Plated | | | | |
| 26 AWG 0.12–0.15 mm ² | 1445361 | 2–28 | 1445370 | 2–28 |
| 28 AWG 0.08–0.09 mm ² | 1445364 | 2–28 | 1445373 | 2–28 |
| 30 AWG 0.05–0.06 mm ² | 1445367 | 2–28 | 1445376 | 2–28 |
| .000015 [0.00038] Gold Plated | | | | |
| 26 AWG 0.12–0.15 mm ² | 1445360 | 2–28 | 1445369 | 2–28 |
| 28 AWG 0.08–0.09 mm ² | 1445363 | 2–28 | 1445372 | 2–28 |
| 30 AWG 0.05–0.06 mm ² | 1445366 | 2–28 | 1445375 | 2–28 |



MTA-50 IDC Connectors and Headers (Continued)

Connector Kits — Ribbon Cable (Continued)

Strain Relief Covers

Material and Finish
Strain Relief Cover — UL 94V-0 rated, thermoplastic, black



MTA-50
.050 [1.27]

Feed-Thru



Feed-Thru

Closed End



Closed End

Feed-Thru and Closed End

| No. of Circuits | Dim. A | No. of Circuits | Dim. A |
|-----------------|---------------|-----------------|----------------|
| 2 | .260 6.60 | 16 | .960 24.38 |
| 3 | .310 7.87 | 17 | 1.010 25.65 |
| 4 | .360 9.14 | 18 | 1.060 26.92 |
| 5 | .410 10.41 | 19 | 1.110 28.19 |
| 6 | .460 11.68 | 20 | 1.160 29.46 |
| 7 | .510 12.95 | 21 | 1.210 30.73 |
| 8 | .560 14.22 | 22 | 1.260 32.00 |
| 9 | .610 15.49 | 23 | 1.310 33.27 |
| 10 | .660 16.76 | 24 | 1.360 34.54 |
| 11 | .710 18.03 | 25 | 1.410 35.81 |
| 12 | .760 19.30 | 26 | 1.460 37.08 |
| 13 | .810 20.57 | 27 | 1.510 38.35 |
| 14 | .860 21.84 | 28 | 1.560 39.62 |
| 15 | .910 23.11 | | |

MTA-50 IDC Connectors and Headers (Continued)

MTA-50
.050 [1.27]

Feed-Thru and Closed End Connectors



Receptacle Assemblies — Discrete Wire



Material and Finish

Housing — UL 94V-2 rated, thermo-plastic

Contacts — Phosphor bronze; .000100 [0.00254] min. tin in wire termination area, over .000050 [0.00127] min. nickel; choice on mating end: .000100 [0.00254] min. tin or .000030 [0.00076] gold or .000015 [0.00038] gold, over .000050 [0.00127] min. nickel

Color Coding by Wire Size for UL94V-0 Connectors

- 26 AWG — Blue
- 28 AWG — Green
- 30 AWG — Brown



Notes:

1. To determine connector overall length (dim. A), multiply .050 x the number of circuits and add .082. Example: .050 x 10 circuits equals 0.50 + .082 = .582 [14.78].
2. Strain relief covers shown on page 8 are required and sold as part of the Connector Kit.
3. Stranded UL Style 1061 or equivalent wire is recommended.
4. Unless otherwise stated all tolerances (except plating) to be ±.005 [±0.13].
5. Consult Product Drawing for RoHS Compliant information.

For Strain Relief Covers see page 8.
For mating Headers see pages 9 and 10.
For Mateability Guide, see matrixes on page 4.

Connector Kits — Discrete Wire

Connector Kit Ordering Information

Connector Kit consists of Receptacle Assembly and Strain Relief Cover.

Base part number prefixes and suffixes indicate the number of circuit positions, for example: Base part number 1445341

- 2 position = 0-1445341-2 and
- 28 position = 2-1445341-8

Note: Tin-plated connectors and headers in even position sizes from 2–12 and 18 are stocked parts; all other position sizes and products with gold-plated contacts are Make To Order.

Base Part Numbers

| Connector Type & Wire Size | Feed-Thru | | Closed End | |
|--------------------------------------|-------------------------|-----------------|-------------------------|-----------------|
| | Connector Kit Part Nos. | No. of Circuits | Connector Kit Part Nos. | No. of Circuits |
| Tin Plated | | | | |
| 26 AWG 0.12–0.15 mm ² | 1445341 | 2–28 | 1445350 | 2–28 |
| 28 AWG 0.08–0.09 mm ² | 1445344 | 2–28 | 1445353 | 2–28 |
| 30 AWG 0.05–0.06 mm ² | 1445347 | 2–28 | 1445356 | 2–28 |
| .000030 [0.00076] Gold Plated | | | | |
| 26 AWG 0.12–0.15 mm ² | 1445343 | 2–28 | 1445352 | 2–28 |
| 28 AWG 0.08–0.09 mm ² | 1445346 | 2–28 | 1445355 | 2–28 |
| 30 AWG 0.05–0.06 mm ² | 1445349 | 2–28 | 1445358 | 2–28 |
| .000015 [0.00038] Gold Plated | | | | |
| 26 AWG 0.12–0.15 mm ² | 1445342 | 2–28 | 1445351 | 2–28 |
| 28 AWG 0.08–0.09 mm ² | 1445345 | 2–28 | 1445354 | 2–28 |
| 30 AWG 0.05–0.06 mm ² | 1445348 | 2–28 | 1445357 | 2–28 |



MTA-50 IDC Connectors and Headers (Continued)

**Connector Kits —
Discrete Wire (Continued)**

Strain Relief Covers

Material and Finish
Strain Relief Cover — UL 94V-0
rated, thermoplastic, black

Feed-Thru



Closed End



Feed-Thru



Closed End

Feed-Thru and Closed End

| No. of Circuits | Dim. A | No. of Circuits | Dim. A |
|-----------------|---------------|-----------------|----------------|
| 2 | .260 6.60 | 16 | .960 24.38 |
| 3 | .310 7.87 | 17 | 1.010 25.65 |
| 4 | .360 9.14 | 18 | 1.060 26.92 |
| 5 | .410 10.41 | 19 | 1.110 28.19 |
| 6 | .460 11.68 | 20 | 1.160 29.46 |
| 7 | .510 12.95 | 21 | 1.210 30.73 |
| 8 | .560 14.22 | 22 | 1.260 32.00 |
| 9 | .610 15.49 | 23 | 1.310 33.27 |
| 10 | .660 16.76 | 24 | 1.360 34.54 |
| 11 | .710 18.03 | 25 | 1.410 35.81 |
| 12 | .760 19.30 | 26 | 1.460 37.08 |
| 13 | .810 20.57 | 27 | 1.510 38.35 |
| 14 | .860 21.84 | 28 | 1.560 39.62 |
| 15 | .910 23.11 | | |

MTA-50
.050 [1.27]

MTA-50 IDC Connectors and Headers (Continued)

Through-Hole Header Assemblies

Vertical



Material and Finish

Housing — UL 94V-0 rated, thermo-plastic, black

Contacts — Brass, .000100 [0.00254] min. tin over .000050 [0.00127] min. nickel on solder legs; choice on mating end:
.000100 [0.00254] min. tin or
.000030 [0.00076] gold or
.000015 [0.00038] gold, over
.000050 [0.00127] min. nickel



Note: To determine header overall length (dim. A), multiply .050 x the number of circuits and add .150. Example: .050 x 6 circuits equals .300 + .150 = .450 [11.43].



Recommended Mounting Hole Size and Pattern for .062 [1.57] Thick PC Board

* 6-circuit Dim. shown, refer to Product Drawing for actual PCB Dimensions and RoHS Compliant information.

Base Part Numbers

| Through-Hole | |
|--------------------------------------------------------|--------------|
| Header Part Nos. | No. of Posts |
| Standard UL 94V-0, Tin Plated | |
| 1445120 | 2-28 |
| Standard UL 94V-0 .000030 [0.00076] Gold Plated | |
| 1445125 | 2-28 |
| Standard UL 94V-0 .000015 [0.00038] Gold Plated | |
| 1445123 | 2-28 |

Right-Angle



For mating Connector Kits see pages 5 through 8.

For mateability options, see matrixes on page 4.

Header Ordering Information

Base part number prefixes and suffixes indicate the number of circuit positions, for example: Base part number 1445120

2 position = 0-1445120-2
and
28 position = 2-1445120-8

Note: Tin-plated connectors and headers in even position sizes from 2-12 and 18 are stocked parts; all other position sizes and products with gold-plated contacts are Make To Order.



Recommended Mounting Hole Size and Pattern for .062 [1.57] Thick PC Board

* 6-circuit Dim. shown, refer to Product Drawing for actual PCB Dimensions and RoHS Compliant information.

Base Part Numbers

| Through-Hole | |
|--------------------------------------------------------|--------------|
| Header Part Nos. | No. of Posts |
| Standard UL 94V-0, Tin Plated | |
| 1445169 | 2-28 |
| Standard UL 94V-0 .000030 [0.00076] Gold Plated | |
| 1445171 | 2-28 |
| Standard UL 94V-0 .000015 [0.00038] Gold Plated | |
| 1445170 | 2-28 |

MTA-50 IDC Connectors and Headers (Continued)

Surface Mount Header Assemblies

Vertical



Material and Finish

Housing — UL 94V-0 rated, thermo-plastic, black

Contacts — Brass, .000100 [0.00254] min. tin over .000050 [0.00127] min. nickel on solder pads; choice on mating end:

.000100 [0.00254] min. tin or
.000030 [0.00076] gold or
.000015 [0.00038] gold, over
.000050 [0.00127] min. nickel

Boardlock — Phosphor bronze, tin plated .000100 [0.000254] min. over .000050 [0.00127] min. nickel

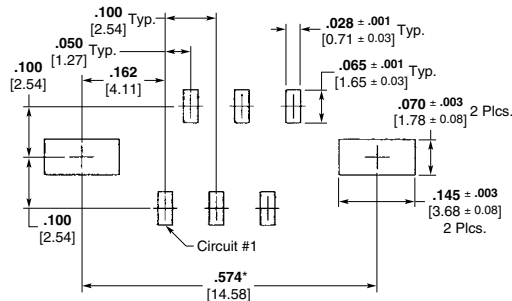

Recommended PC Board Layout
for use with .010 [0.25] Thick Stencil

* 6-circuit Dim. shown, refer to Product Drawing for actual PCB Dimensions and RoHS Compliant information.

Note: To determine header overall length (dim. A), multiply .050 x the number of circuits and add .150. Example: .050 x 6 circuits equals .300 + .150 = .450 [11.43].



Base Part Numbers

| Surface Mount | |
|-------------------------------------------------------|--------------|
| Header Part Nos. | No. of Posts |
| Standard UL 94V-0, Tin Plated | |
| 1445121 | 2-28 |
| Standard UL 94V-0 .00030 [0.00076] Gold Plated | |
| 1445126 | 2-28 |
| Standard UL 94V-0 .00015 [0.00038] Gold Plated | |
| 1445124 | 2-28 |

Note: All SMT product is pre-packaged in standard tape and reel format.

Right-Angle



For mating Connector Kits see pages 5 through 8.

For mateability options, see matrixes on page 4.



Recommended PC Board Layout
for use with .010 [0.25] Thick Stencil

* 6-circuit Dim. shown, refer to Product Drawing for actual PCB Dimensions and RoHS Compliant information.

Base Part Numbers

| Surface Mount | |
|-------------------------------------------------------|--------------|
| Header Part Nos. | No. of Posts |
| Standard UL 94V-0, Tin Plated | |
| 1445172 | 2-28 |
| Standard UL 94V-0 .00030 [0.00076] Gold Plated | |
| 1445174 | 2-28 |
| Standard UL 94V-0 .00015 [0.00038] Gold Plated | |
| 1445173 | 2-28 |

Header Ordering Information

Base part number prefixes and suffixes indicate the number of circuit positions, for example: Base part number 1445121

2 position = 0-1445121-2
and
28 position = 2-1445121-8

Note: Tin-plated connectors and headers in even position sizes from 2-12 and 18 are stocked parts; all other position sizes and products with gold-plated contacts are Make To Order.

MTA-50
.050 [1.27]

.100 [2.54] Centerline MTA-100 IDC Connectors and Headers

Product Facts

- Connectors and headers for 2 through 28 positions; wire sizes of 22, 24, 26 and 28 AWG [0.4-0.08 mm²]
- Wire-to-Post Connectors preloaded with dual beam contacts
- Connectors and headers, except shrouded headers, are end-to-end stackable
- Connector styles include both closed end and feed-thru connectors with locking ramps, with and without polarizing tabs
- Molded ribs on housing do not allow reverse mating
- Posted connectors for 2 through 19 positions
- Connectors preloaded with IDC contacts
- All contacts are slotted for insulation displacement (IDC) terminal technique
- Contacts are lubricated for fretting corrosion protection
- Benefits derived from the MTA-100 system include increased quality and ease of handling such as —
 - One-step assembly
 - No wire stripping
 - No contact damage
 - Reduced wiring errors
 - Simpler tooling
 - Simple maintenance and repair
- Meets the material requirements of Table 23.1 of UL1410 Standards for Television Receiver and Video Products (wire-to-post connectors only)
- Recognized under the Component Program of Underwriters Laboratories Inc., File No. E28476 
- Certified by Canadian Standards Association, File No. LR7189 

Technical Documents

Product Specification

108-1050 MTA-100 Connectors

Application Specifications

114-1019 MTA-100 Connectors

114-1031 MTA-100 Ribbon Cable Assembly



MTA-100 connectors accept discrete and ribbon cable wire sizes ranging from 22–28 AWG [0.4–0.08 mm²] with maximum insulation outside diameter of .060 [1.52] for terminating single wire and .050 [1.27] for mass termination of wires. Tin plated solid, fused stranded, or stranded (7 strands) wire with PVC insulation can be used on 22–28 AWG [0.4–0.9 mm²] MTA-100 connectors and 19 stranded wire on 22–24 AWG [0.4–0.2 mm²] MTA-100 connectors. Only

one wire to be terminated into an IDC contact slot.

The wire-to-post connector housing material is flame retardant thermoplastic, either UL94V-2 or UL94V-0 rated.

A full line of .100 [2.54] centerline headers completes the system. Headers are available with straight or right-angle posts, in flat, polarized or friction lock styles. Headers are available in 2 through 28 positions. Shrouded headers are available in 2 through 14 positions.

Performance Data*

Voltage Rating — 250 vac

Current Rating — 5 amp max.

Low-Level Resistance — 6 mΩ max. initial

Dielectric Withstanding Voltage — 750 vac/1 min.

Insulation Resistance — 5000 MΩ min. initial

Operating Temperature — -55° C to +105° C

Note: Refer to page 70 for approved wire listings.

*Refer to the Product Specification for additional electrical, mechanical and environmental performance tests and requirements.

MTA-100 Connector/Header Mateability Guide

This matrix has been prepared to assist you, our customer, in defining the correct mating halves for the MTA-100 header and connector combination. Where a "Y" is indicated the combination is a valid mating pair. Where an "N" is indicated the combination is not acceptable for mating.

Matrix for Tin Plated Part Numbers

Headers

| | 640452 | 640453 | 640454 | 640455 | 640456 | 640457 | 644456 | 644457 | 644486 | 644488 | 644694 | 644695 | 644803 | 644861 | 644874 | 644875 | 644876 | 644877 | 644892 | 644893 | 644894 | 647047 | 647048 | 647050 | 647051 | 647106 | 647166 | 647502 | 647531 | 647609 | 647623 | 647532 | 1744075 |
|----------|--------|--------|--------|--------|--------|--------|--------|--------|--------|--------|--------|--------|--------|--------|--------|--------|--------|--------|--------|--------|--------|--------|--------|--------|--------|--------|--------|--------|--------|--------|--------|--------|---------|
| 640440 | Y | Y | Y | Y | Y | Y | Y | Y | Y | Y | Y | Y | Y | Y | Y | Y | Y | Y | N | N | N | Y | Y | Y | Y | Y | Y | Y | Y | Y | Y | Y | |
| 640441 | Y | Y | Y | Y | Y | Y | Y | Y | Y | Y | Y | Y | Y | Y | Y | Y | Y | Y | N | N | N | Y | Y | Y | Y | Y | Y | Y | Y | Y | Y | Y | |
| 640442 | Y | Y | Y | Y | Y | Y | Y | Y | Y | Y | Y | Y | Y | Y | Y | Y | Y | Y | N | N | N | Y | Y | Y | Y | Y | Y | Y | Y | Y | Y | Y | |
| 640443 | Y | Y | Y | Y | Y | Y | Y | Y | Y | Y | Y | Y | Y | Y | Y | Y | Y | Y | N | N | N | Y | Y | Y | Y | Y | Y | Y | Y | Y | Y | Y | |
| 640468 | Y | Y | Y | Y | Y | Y | Y | Y | Y | Y | Y | Y | Y | Y | Y | Y | Y | Y | N | N | N | Y | Y | Y | Y | Y | Y | Y | Y | Y | Y | Y | |
| 640469 | Y | Y | Y | Y | Y | Y | Y | Y | Y | Y | Y | Y | Y | Y | Y | Y | Y | Y | N | N | N | Y | Y | Y | Y | Y | Y | Y | Y | Y | Y | Y | |
| 640470 | Y | Y | Y | Y | Y | Y | Y | Y | Y | Y | Y | Y | Y | Y | Y | Y | Y | Y | N | N | N | Y | Y | Y | Y | Y | Y | Y | Y | Y | Y | Y | |
| 640471 | Y | Y | Y | Y | Y | Y | Y | Y | Y | Y | Y | Y | Y | Y | Y | Y | Y | Y | N | N | N | Y | Y | Y | Y | Y | Y | Y | Y | Y | Y | Y | |
| 640620 | Y | Y | Y | Y | Y | Y | Y | Y | Y | Y | Y | Y | Y | Y | Y | Y | Y | Y | N | N | N | Y | Y | Y | Y | Y | Y | Y | Y | Y | Y | Y | |
| 640621 | Y | Y | Y | Y | Y | Y | Y | Y | Y | Y | Y | Y | Y | Y | Y | Y | Y | Y | N | N | N | Y | Y | Y | Y | Y | Y | Y | Y | Y | Y | Y | |
| 640622 | Y | Y | Y | Y | Y | Y | Y | Y | Y | Y | Y | Y | Y | Y | Y | Y | Y | Y | N | N | N | Y | Y | Y | Y | Y | Y | Y | Y | Y | Y | Y | |
| 640623 | Y | Y | Y | Y | Y | Y | Y | Y | Y | Y | Y | Y | Y | Y | Y | Y | Y | Y | N | N | N | Y | Y | Y | Y | Y | Y | Y | Y | Y | Y | Y | |
| 641311 | Y | Y | Y | Y | Y | Y | Y | Y | Y | Y | Y | Y | Y | Y | Y | Y | Y | Y | N | N | N | Y | Y | Y | Y | Y | Y | Y | Y | Y | Y | Y | |
| 641312 | Y | Y | Y | Y | Y | Y | Y | Y | Y | Y | Y | Y | Y | Y | Y | Y | Y | Y | N | N | N | Y | Y | Y | Y | Y | Y | Y | Y | Y | Y | Y | |
| 641313 | Y | Y | Y | Y | Y | Y | Y | Y | Y | Y | Y | Y | Y | Y | Y | Y | Y | Y | N | N | N | Y | Y | Y | Y | Y | Y | Y | Y | Y | Y | Y | |
| 641314 | Y | Y | Y | Y | Y | Y | Y | Y | Y | Y | Y | Y | Y | Y | Y | Y | Y | Y | N | N | N | Y | Y | Y | Y | Y | Y | Y | Y | Y | Y | Y | |
| 641534 | Y | Y | Y | Y | Y | Y | Y | Y | Y | Y | Y | Y | Y | Y | Y | Y | Y | Y | N | N | N | Y | Y | Y | Y | Y | Y | Y | Y | Y | Y | Y | |
| 641535 | Y | Y | Y | Y | Y | Y | Y | Y | Y | Y | Y | Y | Y | Y | Y | Y | Y | Y | N | N | N | Y | Y | Y | Y | Y | Y | Y | Y | Y | Y | Y | |
| 641536 | Y | Y | Y | Y | Y | Y | Y | Y | Y | Y | Y | Y | Y | Y | Y | Y | Y | Y | N | N | N | Y | Y | Y | Y | Y | Y | Y | Y | Y | Y | Y | |
| 641537 | Y | Y | Y | Y | Y | Y | Y | Y | Y | Y | Y | Y | Y | Y | Y | Y | Y | Y | N | N | N | Y | Y | Y | Y | Y | Y | Y | Y | Y | Y | Y | |
| 641653 | Y | Y | Y | Y | Y | Y | Y | Y | Y | Y | Y | Y | Y | Y | Y | Y | Y | Y | N | N | N | Y | Y | Y | Y | Y | Y | Y | Y | Y | Y | Y | |
| 641654 | Y | Y | Y | Y | Y | Y | Y | Y | Y | Y | Y | Y | Y | Y | Y | Y | Y | Y | N | N | N | Y | Y | Y | Y | Y | Y | Y | Y | Y | Y | Y | |
| 641655 | Y | Y | Y | Y | Y | Y | Y | Y | Y | Y | Y | Y | Y | Y | Y | Y | Y | Y | N | N | N | Y | Y | Y | Y | Y | Y | Y | Y | Y | Y | Y | |
| 641656 | Y | Y | Y | Y | Y | Y | Y | Y | Y | Y | Y | Y | Y | Y | Y | Y | Y | Y | N | N | N | Y | Y | Y | Y | Y | Y | Y | Y | Y | Y | Y | |
| 643498 | Y | Y | Y | Y | Y | Y | Y | Y | Y | Y | Y | Y | Y | Y | Y | Y | Y | Y | N | N | N | Y | Y | Y | Y | Y | Y | Y | Y | Y | Y | Y | |
| 643813 | Y | Y | Y | Y | Y | Y | Y | Y | Y | Y | Y | Y | Y | Y | Y | Y | Y | Y | N | N | N | Y | Y | Y | Y | Y | Y | Y | Y | Y | Y | Y | |
| 643814 | Y | Y | Y | Y | Y | Y | Y | Y | Y | Y | Y | Y | Y | Y | Y | Y | Y | Y | N | N | N | Y | Y | Y | Y | Y | Y | Y | Y | Y | Y | Y | |
| 643815 | Y | Y | Y | Y | Y | Y | Y | Y | Y | Y | Y | Y | Y | Y | Y | Y | Y | Y | N | N | N | Y | Y | Y | Y | Y | Y | Y | Y | Y | Y | Y | |
| 643816 | Y | Y | Y | Y | Y | Y | Y | Y | Y | Y | Y | Y | Y | Y | Y | Y | Y | Y | N | N | N | Y | Y | Y | Y | Y | Y | Y | Y | Y | Y | Y | |
| 643828 | Y | Y | Y | Y | Y | Y | Y | Y | Y | Y | Y | Y | Y | Y | Y | Y | Y | Y | N | N | N | Y | Y | Y | Y | Y | Y | Y | Y | Y | Y | Y | |
| 644083 | Y | Y | Y | Y | Y | Y | Y | Y | Y | Y | Y | Y | Y | Y | Y | Y | Y | Y | N | N | N | Y | Y | Y | Y | Y | Y | Y | Y | Y | Y | Y | |
| 644312 | Y | Y | Y | Y | Y | Y | Y | Y | Y | Y | Y | Y | Y | Y | Y | Y | Y | Y | N | N | N | Y | Y | Y | Y | Y | Y | Y | Y | Y | Y | Y | |
| 644313 | Y | Y | Y | Y | Y | Y | Y | Y | Y | Y | Y | Y | Y | Y | Y | Y | Y | Y | N | N | N | Y | Y | Y | Y | Y | Y | Y | Y | Y | Y | Y | |
| 644497 | Y | Y | Y | Y | Y | Y | Y | Y | Y | Y | Y | Y | Y | Y | Y | Y | Y | Y | N | N | N | Y | Y | Y | Y | Y | Y | Y | Y | Y | Y | Y | |
| 644511 | Y | Y | Y | Y | Y | Y | Y | Y | Y | Y | Y | Y | Y | Y | Y | Y | Y | Y | N | N | N | Y | Y | Y | Y | Y | Y | Y | Y | Y | Y | Y | |
| 644512 | Y | Y | Y | Y | Y | Y | Y | Y | Y | Y | Y | Y | Y | Y | Y | Y | Y | Y | N | N | N | Y | Y | Y | Y | Y | Y | Y | Y | Y | Y | Y | |
| 644513 | Y | Y | Y | Y | Y | Y | Y | Y | Y | Y | Y | Y | Y | Y | Y | Y | Y | Y | N | N | N | Y | Y | Y | Y | Y | Y | Y | Y | Y | Y | Y | |
| 644514 | Y | Y | Y | Y | Y | Y | Y | Y | Y | Y | Y | Y | Y | Y | Y | Y | Y | Y | N | N | N | Y | Y | Y | Y | Y | Y | Y | Y | Y | Y | Y | |
| 644540 | Y | Y | Y | Y | Y | Y | Y | Y | Y | Y | Y | Y | Y | Y | Y | Y | Y | Y | N | N | N | Y | Y | Y | Y | Y | Y | Y | Y | Y | Y | Y | |
| 644563 | Y | Y | Y | Y | Y | Y | Y | Y | Y | Y | Y | Y | Y | Y | Y | Y | Y | Y | N | N | N | Y | Y | Y | Y | Y | Y | Y | Y | Y | Y | Y | |
| 644564 | Y | Y | Y | Y | Y | Y | Y | Y | Y | Y | Y | Y | Y | Y | Y | Y | Y | Y | N | N | N | Y | Y | Y | Y | Y | Y | Y | Y | Y | Y | Y | |
| 644565 | Y | Y | Y | Y | Y | Y | Y | Y | Y | Y | Y | Y | Y | Y | Y | Y | Y | Y | N | N | N | Y | Y | Y | Y | Y | Y | Y | Y | Y | Y | Y | |
| 644574 | Y | Y | Y | Y | Y | Y | Y | Y | Y | Y | Y | Y | Y | Y | Y | Y | Y | Y | N | N | N | Y | Y | Y | Y | Y | Y | Y | Y | Y | Y | Y | |
| 644575 | Y | Y | Y | Y | Y | Y | Y | Y | Y | Y | Y | Y | Y | Y | Y | Y | Y | Y | N | N | N | Y | Y | Y | Y | Y | Y | Y | Y | Y | Y | Y | |
| 644576 | Y | Y | Y | Y | Y | Y | Y | Y | Y | Y | Y | Y | Y | Y | Y | Y | Y | Y | N | N | N | Y | Y | Y | Y | Y | Y | Y | Y | Y | Y | Y | |
| 644577 | Y | Y | Y | Y | Y | Y | Y | Y | Y | Y | Y | Y | Y | Y | Y | Y | Y | Y | N | N | N | Y | Y | Y | Y | Y | Y | Y | Y | Y | Y | Y | |
| 644578 | Y | Y | Y | Y | Y | Y | Y | Y | Y | Y | Y | Y | Y | Y | Y | Y | Y | Y | N | N | N | Y | Y | Y | Y | Y | Y | Y | Y | Y | Y | Y | |
| 644579 | Y | Y | Y | Y | Y | Y | Y | Y | Y | Y | Y | Y | Y | Y | Y | Y | Y | Y | N | N | N | Y | Y | Y | Y | Y | Y | Y | Y | Y | Y | Y | |
| 644795 | Y | Y | Y | Y | Y | Y | Y | Y | Y | Y | Y | Y | Y | Y | Y | Y | Y | Y | N | N | N | Y | Y | Y | Y | Y | Y | Y | Y | Y | Y | Y | |
| *1375820 | Y | Y | Y | Y | Y | Y | Y | N | N | Y | Y | N | N | Y | Y | Y | Y | Y | Y | Y | Y | Y | Y | Y | Y | Y | Y | Y | Y | Y | Y | Y | |

*Select contact plating to match header plating.

MTA-100
.100 [2.54]

Connectors

MTA-100 Connector/Header Mateability Guide (Continued)

This matrix has been prepared to assist you, our customer, in defining the correct mating halves for the MTA-100 header and connector combination. Where a "Y" is indicated the combination is a valid mating pair. Where an "N" is indicated the combination is not acceptable for mating.

**Matrix for .000030
[0.00076] Gold Plated
Part Numbers**

| Connectors | Headers | | | | | | | | | | | | | | | | | | | | | | | | | |
|------------|---------|--------|--------|--------|--------|--------|--------|--------|--------|--------|--------|--------|--------|--------|--------|--------|--------|--------|--------|--------|--------|--------|--------|--------|--------|--------|
| | 641211 | 641212 | 641213 | 641214 | 641215 | 641216 | 644487 | 644489 | 644884 | 644885 | 644886 | 644887 | 644896 | 644897 | 644898 | 647108 | 647109 | 647114 | 647116 | 647117 | 647168 | 647626 | 647624 | 647534 | 744047 | 744163 |
| 641237 | Y | Y | Y | Y | Y | Y | Y | Y | Y | Y | Y | Y | N | N | N | Y | Y | Y | Y | Y | Y | Y | Y | Y | Y | Y |
| 641238 | Y | Y | Y | Y | Y | Y | Y | Y | Y | Y | Y | Y | N | N | N | Y | Y | Y | Y | Y | Y | Y | Y | Y | Y | Y |
| 641239 | Y | Y | Y | Y | Y | Y | Y | Y | Y | Y | Y | Y | N | N | N | Y | Y | Y | Y | Y | Y | Y | Y | Y | Y | Y |
| 641240 | Y | Y | Y | Y | Y | Y | Y | Y | Y | Y | Y | Y | N | N | N | Y | Y | Y | Y | Y | Y | Y | Y | Y | Y | Y |
| 641241 | Y | Y | Y | Y | Y | Y | Y | Y | Y | Y | Y | Y | N | N | N | Y | Y | Y | Y | Y | Y | Y | Y | Y | Y | Y |
| 641242 | Y | Y | Y | Y | Y | Y | Y | Y | Y | Y | Y | Y | N | N | N | Y | Y | Y | Y | Y | Y | Y | Y | Y | Y | Y |
| 641243 | Y | Y | Y | Y | Y | Y | Y | Y | Y | Y | Y | Y | N | N | N | Y | Y | Y | Y | Y | Y | Y | Y | Y | Y | Y |
| 641244 | Y | Y | Y | Y | Y | Y | Y | Y | Y | Y | Y | Y | N | N | N | Y | Y | Y | Y | Y | Y | Y | Y | Y | Y | Y |
| 644020 | Y | Y | Y | Y | Y | Y | Y | Y | Y | Y | Y | Y | N | N | N | Y | Y | Y | Y | Y | Y | Y | Y | Y | Y | Y |
| 644042 | Y | Y | Y | Y | Y | Y | Y | Y | Y | Y | Y | Y | N | N | N | Y | Y | Y | Y | Y | Y | Y | Y | Y | Y | Y |
| 644043 | Y | Y | Y | Y | Y | Y | Y | Y | Y | Y | Y | Y | N | N | N | Y | Y | Y | Y | Y | Y | Y | Y | Y | Y | Y |
| 644044 | Y | Y | Y | Y | Y | Y | Y | Y | Y | Y | Y | Y | N | N | N | Y | Y | Y | Y | Y | Y | Y | Y | Y | Y | Y |
| 644702 | Y | Y | Y | Y | Y | Y | Y | Y | Y | Y | Y | Y | N | N | N | Y | Y | Y | Y | Y | Y | Y | Y | Y | Y | Y |
| 644726 | Y | Y | Y | Y | Y | Y | Y | Y | Y | Y | Y | Y | N | N | N | Y | Y | Y | Y | Y | Y | Y | Y | Y | Y | Y |
| *1375820 | Y | Y | Y | Y | Y | Y | N | N | Y | Y | Y | Y | Y | Y | Y | Y | Y | Y | Y | Y | Y | Y | Y | Y | Y | Y |

**Matrix for .000015
[0.00038] Gold Plated
Part Numbers**

| Connectors | Headers | | | | | | | | | | | | | | | | | | | | | | | | | |
|------------|---------|--------|--------|--------|--------|--------|--------|--------|--------|--------|--------|--------|--------|--------|--------|--------|--------|--------|--------|--------|---------|---|---|---|---|---|
| | 641122 | 641123 | 641124 | 641125 | 641126 | 641127 | 644888 | 644889 | 644890 | 644891 | 647075 | 647076 | 647078 | 647079 | 647107 | 647167 | 647467 | 647625 | 647627 | 647533 | 1744074 | | | | | |
| 641190 | Y | Y | Y | Y | Y | Y | Y | Y | Y | Y | Y | Y | Y | Y | Y | Y | Y | Y | Y | Y | Y | Y | Y | Y | Y | |
| 641191 | Y | Y | Y | Y | Y | Y | Y | Y | Y | Y | Y | Y | Y | Y | Y | Y | Y | Y | Y | Y | Y | Y | Y | Y | Y | |
| 641192 | Y | Y | Y | Y | Y | Y | Y | Y | Y | Y | Y | Y | Y | Y | Y | Y | Y | Y | Y | Y | Y | Y | Y | Y | Y | |
| 641193 | Y | Y | Y | Y | Y | Y | Y | Y | Y | Y | Y | Y | Y | Y | Y | Y | Y | Y | Y | Y | Y | Y | Y | Y | Y | |
| 641198 | Y | Y | Y | Y | Y | Y | Y | Y | Y | Y | Y | Y | Y | Y | Y | Y | Y | Y | Y | Y | Y | Y | Y | Y | Y | |
| 641199 | Y | Y | Y | Y | Y | Y | Y | Y | Y | Y | Y | Y | Y | Y | Y | Y | Y | Y | Y | Y | Y | Y | Y | Y | Y | |
| 641200 | Y | Y | Y | Y | Y | Y | Y | Y | Y | Y | Y | Y | Y | Y | Y | Y | Y | Y | Y | Y | Y | Y | Y | Y | Y | |
| 641201 | Y | Y | Y | Y | Y | Y | Y | Y | Y | Y | Y | Y | Y | Y | Y | Y | Y | Y | Y | Y | Y | Y | Y | Y | Y | |
| 644038 | Y | Y | Y | Y | Y | Y | Y | Y | Y | Y | Y | Y | Y | Y | Y | Y | Y | Y | Y | Y | Y | Y | Y | Y | Y | |
| 644040 | Y | Y | Y | Y | Y | Y | Y | Y | Y | Y | Y | Y | Y | Y | Y | Y | Y | Y | Y | Y | Y | Y | Y | Y | Y | |
| 647477 | Y | Y | Y | Y | Y | Y | Y | Y | Y | Y | Y | Y | Y | Y | Y | Y | Y | Y | Y | Y | Y | Y | Y | Y | Y | |
| 647480 | Y | Y | Y | Y | Y | Y | Y | Y | Y | Y | Y | Y | Y | Y | Y | Y | Y | Y | Y | Y | Y | Y | Y | Y | Y | |
| *1375820 | N | N | N | N | N | N | N | N | N | N | N | N | N | N | N | N | N | N | N | N | N | N | Y | Y | Y | Y |
| 1744020 | Y | Y | Y | Y | Y | Y | Y | Y | Y | Y | Y | Y | Y | Y | Y | Y | Y | Y | Y | Y | Y | Y | Y | Y | Y | |

*Select contact plating to match header plating.

MTA-100
.100 [2.54]

MTA-100 IDC Connectors—Closed End and Feed-Thru

Material and Finish

Housing—UL94V-2 rated, nylon, see below for color; or UL94V-0 rated, nylon, black

Contacts—Phosphor bronze, post tin plated, .000030 [0.00076] or .000015 [0.00038] post gold-plated over nickel

Color Coding by Wire Size for UL94V-2 Connectors

28 AWG—Green

26 AWG—Blue

24 AWG—White

22 AWG—Red

All wire sizes in UL94V-0—Black

For mateability options, see matrix on pages 12 and 13.

For mating half visuals, see pages 20 thru 30.

Notes:

1. Refer to pages 70-74 for approved wire listing.
2. For strain reliefs and dust covers, see page 16.
3. For keying plugs, see page 17.
4. Other circuit sizes are available upon request. Minimums may apply.
5. Connector circuits can be molded closed for keying purposes. Minimums may apply.
6. Where no part numbers appear in the chart, parts can be made available upon request. Minimums may apply.
7. To determine connector overall length (dim. A), multiply .100 x the number of circuits. Example: .100 x 10 circuits equals 1.000 inch [25.4 mm].

Closed End Connectors

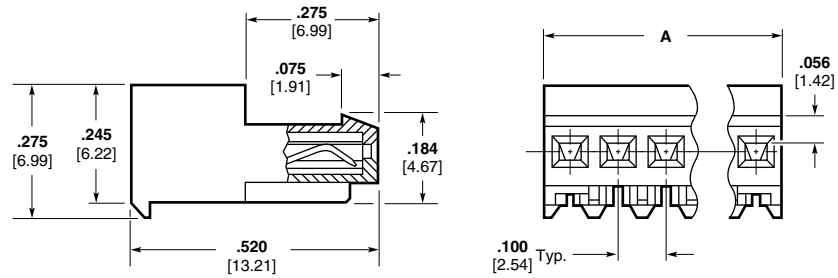

Without Polarizing Tabs

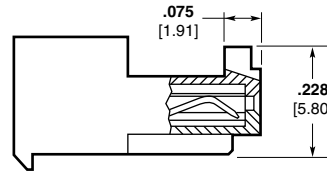

With Polarizing Tabs

Feed-Thru Connectors

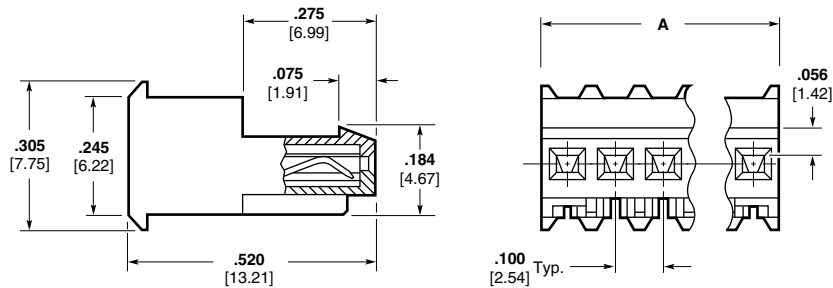

Without Polarizing Tabs

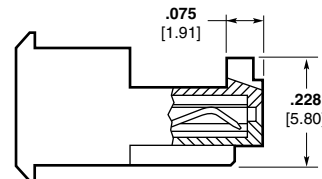

With Polarizing Tabs

MTA-100
.100 [2.54]

Connector Ordering Information

The "Base Part Numbers" Chart at right shows the base part number, and their RoHS (Restrictions on Certain Hazardous Substances) Compliant (lead free) equivalent available for the described connectors.

Prefixes and suffixes are determined by the number of circuit positions in the connector. For example, the complete part number for a 10-position closed end connector without polarizing tabs for 22 AWG wire would be:

Base number **640440** plus prefix-and-suffix
4- -0

The correct ordering number is **4-640440-0**

All part numbers are the RoHS equivalent version. Example:

| No. of Pos. | Lead Free RoHS Prefix/Suffix |
|-------------|------------------------------|
| 2 | 3-640440-2 |
| 3 | 3-640440-3 |
| 4 | 3-640440-4 |
| 5 | 3-640440-5 |
| 6 | 3-640440-6 |
| 7 | 3-640440-7 |
| 8 | 3-640440-8 |
| 9 | 3-640440-9 |
| 10 | 4-640440-0 |
| 11 | 4-640440-1 |
| 12 | 4-640440-2 |
| 13 | 4-640440-3 |
| 14 | 4-640440-4 |
| 15 | 4-640440-5 |
| 16 | 4-640440-6 |
| 17 | 4-640440-7 |
| 18 | 4-640440-8 |
| 19 | 4-640440-9 |
| 20 | 5-640440-0 |
| 21 | 5-640440-1 |
| 22 | 5-640440-2 |
| 23 | 5-640440-3 |
| 24 | 5-640440-4 |
| 25 | 5-640440-5 |
| 26 | 5-640440-6 |
| 27 | 5-640440-7 |
| 28 | 5-640440-8 |

Note: All RoHS equivalent part numbers may not be available upon catalog release. If the number you need is not available, please contact Product Engineering to expedite your request.

MTA-100 IDC Connectors—Closed End and Feed-Thru (Continued)

Base Part Numbers

| Connector Type & Wire Size | Closed End | | | | Feed-Thru | | | |
|-----------------------------------------------------------------------------------------------|---------------------|--------------|----------------------|--------------|---------------------|--------------|---------------------|--------------|
| | Without Tabs | | With Tabs | | Without Tabs | | With Tabs | |
| | Connector Part Nos. | RoHS Equiv. | Connector Part Nos. | RoHS Equiv. | Connector Part Nos. | RoHS Equiv. | Connector Part Nos. | RoHS Equiv. |
| Standard UL94V-2, Tin Plated | | | | | | | | |
| 22 AWG 0.3–0.4 mm ² | 640440 | 32–58 | 643813 | 32–58 | 640620 | 32–58 | 644540 ¹ | 32–45 |
| 24 AWG 0.2 mm ² | 640441 | 32–58 | 643814 | 32–58 | 640621 | 32–58 | 644563 ¹ | 32–54 |
| 26 AWG 0.12–0.15 mm ² | 640442 | 32–58 | 643815 | 32–58 | 640622 | 32–58 | 644564 ¹ | 32–45 |
| 28 AWG 0.08–0.09 mm ² | 640443 | 32–58 | 643816 | 32–58 | 640623 | 32–58 | 644565 ¹ | 32–45 |
| Tape Mounted on Reel UL94V-2, Tin Plated | | | | | | | | |
| 22 AWG 0.3–0.4 mm ² | 640468 | 32–58 | 644511 | 42–68 | 641311 | 32–58 | — | — |
| 24 AWG 0.2 mm ² | 640469 | 32–58 | 644512 | 32–58 | 641312 | 32–58 | — | — |
| 26 AWG 0.12–0.15 mm ² | 640470 | 32–58 | 644513 | 32–58 | 641313 | 32–58 | — | — |
| 28 AWG 0.08–0.09 mm ² | 640471 | 32–58 | 644514 | 32–58 | 641314 | 32–58 | — | — |
| Standard UL94V-2, .000030 [0.00076] Gold Plated | | | | | | | | |
| 22 AWG 0.3–0.4 mm ² | 641237 | 32–58 | 644042 | 32–58 | 641241 | 32–58 | 644702 ¹ | 32–45 |
| 24 AWG 0.2 mm ² | 641238 | 32–58 | 644020 | 32–58 | 641242 | 32–58 | — | — |
| 26 AWG 0.12–0.15 mm ² | 641239 | 32–58 | 644043 ¹ | 32–44 | 641243 | 32–58 | 644726 ¹ | 32–45 |
| 28 AWG 0.8–0.9 mm ² | 641240 | 32–58 | 644044 ¹ | 32–44 | 641244 | 32–58 | — | — |
| Standard UL94V-2, .000015 [0.00038] Gold Plated | | | | | | | | |
| 22 AWG 0.3–0.4 mm ² | 641190 | 32–58 | 644038 ¹ | 32–44 | 641198 | 32–58 | 647477 | 32–46 |
| 24 AWG 0.2 mm ² | 641191 | 32–58 | 1744020 ¹ | 32–44 | 641199 | 32–58 | — | — |
| 26 AWG 0.12–0.15 mm ² | 641192 | 32–58 | 644040 ¹ | 32–44 | 641200 | 32–58 | 647480 | 32–43 |
| 28 AWG 0.08–0.09 mm ² | 641193 | 32–58 | — | — | 641201 | 32–58 | — | — |
| LED*, UL94V-2, Tin Plated (See Note 1) | | | | | | | | |
| 22 AWG 0.3–0.4 mm ² | 641534 | 32–33 | — | — | 641653 | 32–33 | — | — |
| 24 AWG 0.2 mm ² | 641535 | 32–33 | 644795 | 32–33 | 641654 | 32–33 | — | — |
| 26 AWG 0.12–0.15 mm ² | 641536 | 32–33 | — | — | 641655 | 32–33 | — | — |
| 28 AWG 0.08–0.09 mm ² | 641537 | 32–33 | — | — | 641656 | 32–33 | — | — |
| Standard UL94V-0, Tin Plated (Gold is available, minimums may apply.) (Black in color) | | | | | | | | |
| 22 AWG 0.3–0.4 mm ² | 643498 ¹ | 32–45 | 644083 ¹ | 32–45 | 644575 ¹ | 32–45 | 644578 ¹ | 32–45 |
| 24 AWG 0.2 mm ² | 644574 ¹ | 32–45 | 644312 ¹ | 32–45 | 644576 ¹ | 32–45 | 644579 ¹ | 32–45 |
| 26 AWG 0.12–0.15 mm ² | 643828 ¹ | 32–45 | 644313 ¹ | 32–45 | 644577 ¹ | 32–45 | 644497 ¹ | 32–45 |

*LED connectors are designed to mate with .014–.020 [0.36–0.51] diameter posts or square leads.

¹ Other circuit sizes are available upon request. Minimums may apply.

² Tape mounted.

Note: Blocked circuit configurations are available. Contact product engineer or product manager for details. Minimums may apply.

MTA-100 IDC Connector Accessories

Covers

Material (RoHS Compliant)

Strain Relief Cover — UL94V-2 rated, nylon, white

Dust Covers — UL94V-0 rated, polyester, white

Closed End Strain Relief Covers



Closed End Dust Covers



Feed-Thru Strain Relief Covers



Feed-Thru Dust Covers



Cover Ordering Information

The "Base Part Numbers" Chart at right shows the base part number and number of circuits available for the described cover.

Prefixes and suffixes are determined by the number of circuit positions in the cover. For example, the complete part number for a 10-position closed end strain relief cover would be:

Base number **643075** plus prefix-and-suffix

1- -0

The correct ordering number is

1-643075-0

Base Part Numbers

| Closed End | | | | Feed-Thru | | | |
|----------------------|-----------------|-----------------|-----------------|----------------------|-----------------|-----------------|-----------------|
| Strain Relief Covers | | Dust Covers | | Strain Relief Covers | | Dust Covers | |
| Cover Part Nos. | No. of Circuits | Cover Part Nos. | No. of Circuits | Cover Part Nos. | No. of Circuits | Cover Part Nos. | No. of Circuits |
| 643075 | 2-28 | 640550 | 2-28 | 643077 | 2-28 | 640642 | 3-28 |

Cover Length

| No. of Circuits | Dim. A | Prefix/Suffix | No. of Circuits | Dim. A | Prefix/Suffix | No. of Circuits | Dim. A | Prefix/Suffix | No. of Circuits | Dim. A | Prefix/Suffix |
|-----------------|---------------|---------------|-----------------|----------------|---------------|-----------------|----------------|---------------|-----------------|----------------|---------------|
| 2 | .200 5.08 | -2 | 9 | .900 22.86 | -9 | 16 | 1.600 40.64 | 1- -6 | 23 | 2.300 58.42 | 2- -3 |
| 3 | .300 7.62 | -3 | 10 | 1.00 25.4 | 1- -0 | 17 | 1.700 43.18 | 1- -7 | 24 | 2.400 60.96 | 2- -4 |
| 4 | .400 10.16 | -4 | 11 | 1.100 27.94 | 1- -1 | 18 | 1.800 45.72 | 1- -8 | 25 | 2.500 63.5 | 2- -5 |
| 5 | .500 12.7 | -5 | 12 | 1.200 30.48 | 1- -2 | 19 | 1.900 48.26 | 1- -9 | 26 | 2.600 66.04 | 2- -6 |
| 6 | .600 15.24 | -6 | 13 | 1.300 33.02 | 1- -3 | 20 | 2.000 50.8 | 2- -0 | 27 | 2.700 68.58 | 2- -7 |
| 7 | .700 17.78 | -7 | 14 | 1.400 35.56 | 1- -4 | 21 | 2.100 53.34 | 2- -1 | 28 | 2.800 71.12 | 2- -8 |
| 8 | .800 20.32 | -8 | 15 | 1.500 38.1 | 1- -5 | 22 | 2.200 55.88 | 2- -2 | | | |

MTA-100
.100 [2.54]

MTA-100 IDC Connector Accessories (Continued)

**Keying Plug with Carrier Strip (10 plugs per strip)
Part No. 641994-1**

Material (RoHS Compliant)
UL94V-2 rated, nylon, natural color



Note: Removal of contact is not necessary when using keying plug.



Replacement IDC Contacts

Material and Finish

Phosphor bronze, post tin plated;
.000030 [0.00076] or .000015 [0.00038] post gold plated over nickel

| Wire Size | | Part Numbers | | | |
|-----------|-----------------|---------------------|-------------------------------|-------------------------------|----------------|
| AWG | mm ² | Standard Tin Plated | .000030 [0.00076] Gold Plated | .000015 [0.00038] Gold Plated | LED Tin Plated |
| 22 | 0.3–0.4 | 640636-3 | 641186-4 | 641186-3 | 641643-2 |
| 24 | 0.2 | 640637-3 | 641187-4 | 641187-3 | 641644-2 |
| 26 | 0.12–0.15 | 640638-3 | 641188-4 | 641188-3 | 641645-2 |
| 28 | 0.08–0.09 | 640639-2 | 641189-4 | 641189-3 | 641646-2 |

Note: Tyco Electronics does not recommend terminating an MTA contact more than one time. Use replacement contacts when required for field repairs or wire changes.



Crimp Snap-In Contacts

Material and Finish

Phosphor bronze, tin plated



| Wire Size | | Part Nos. | |
|-----------|-----------------|--------------|----------|
| AWG | mm ² | Loose Piece* | Strip** |
| 26-22 | 0.12–0.4 | 640709-2 | 640708-2 |

**Hand Tool No. 59836-1 (IS 408-6527)
**Applicator No. 466747-1 (IS 408-8040)

- Special applications for crimp snap-in contacts are:
1. Double wire per contact
 2. Coax or shielded wire
 3. Mixed wire size in same connector

Note: Only one crimp snap-in contact per connector.

MTA-100 Posted Connector/Connector Mateability Guide

This matrix has been prepared to assist you, our customer, in defining the correct mating halves for the MTA-100 posted connector and connector combination. Where a "Y" is indicated the combination is a valid mating pair. Where an "N" is indicated the combination is not acceptable for mating.

Matrix for Tin Plated Part Numbers

Posted Connectors

| | 647000 | 647001 | 647002 | 647003 | 647004 | 647005 | 647006 | 647007 |
|---------|--------|--------|--------|--------|--------|--------|--------|--------|
| 640440 | Y | Y | Y | Y | Y | Y | Y | Y |
| 640441 | Y | Y | Y | Y | Y | Y | Y | Y |
| 640442 | Y | Y | Y | Y | Y | Y | Y | Y |
| 640443 | Y | Y | Y | Y | Y | Y | Y | Y |
| 640468 | Y | Y | Y | Y | Y | Y | Y | Y |
| 640469 | Y | Y | Y | Y | Y | Y | Y | Y |
| 640470 | Y | Y | Y | Y | Y | Y | Y | Y |
| 640471 | Y | Y | Y | Y | Y | Y | Y | Y |
| 640620 | Y | Y | Y | Y | Y | Y | Y | Y |
| 640621 | Y | Y | Y | Y | Y | Y | Y | Y |
| 640622 | Y | Y | Y | Y | Y | Y | Y | Y |
| 640623 | Y | Y | Y | Y | Y | Y | Y | Y |
| 641311 | Y | Y | Y | Y | Y | Y | Y | Y |
| 641312 | Y | Y | Y | Y | Y | Y | Y | Y |
| 641313 | Y | Y | Y | Y | Y | Y | Y | Y |
| 641314 | Y | Y | Y | Y | Y | Y | Y | Y |
| 641534 | Y | Y | Y | Y | Y | Y | Y | Y |
| 641535 | Y | Y | Y | Y | Y | Y | Y | Y |
| 641536 | Y | Y | Y | Y | Y | Y | Y | Y |
| 641537 | Y | Y | Y | Y | Y | Y | Y | Y |
| 641653 | Y | Y | Y | Y | Y | Y | Y | Y |
| 641654 | Y | Y | Y | Y | Y | Y | Y | Y |
| 641655 | Y | Y | Y | Y | Y | Y | Y | Y |
| 641656 | Y | Y | Y | Y | Y | Y | Y | Y |
| 643498 | Y | Y | Y | Y | Y | Y | Y | Y |
| 643813 | Y* | Y* | Y* | Y* | Y* | Y* | Y* | Y* |
| 643814 | Y* | Y* | Y* | Y* | Y* | Y* | Y* | Y* |
| 643815 | Y* | Y* | Y* | Y* | Y* | Y* | Y* | Y* |
| 643816 | Y* | Y* | Y* | Y* | Y* | Y* | Y* | Y* |
| 643828 | Y | Y | Y | Y | Y | Y | Y | Y |
| 644083 | Y* | Y* | Y* | Y* | Y* | Y* | Y* | Y* |
| 644312 | Y* | Y* | Y* | Y* | Y* | Y* | Y* | Y* |
| 644313 | Y* | Y* | Y* | Y* | Y* | Y* | Y* | Y* |
| 644497 | Y* | Y* | Y* | Y* | Y* | Y* | Y* | Y* |
| 644511 | Y* | Y* | Y* | Y* | Y* | Y* | Y* | Y* |
| 644512 | Y* | Y* | Y* | Y* | Y* | Y* | Y* | Y* |
| 644513 | Y* | Y* | Y* | Y* | Y* | Y* | Y* | Y* |
| 644514 | Y* | Y* | Y* | Y* | Y* | Y* | Y* | Y* |
| 644540 | Y* | Y* | Y* | Y* | Y* | Y* | Y* | Y* |
| 644563 | Y* | Y* | Y* | Y* | Y* | Y* | Y* | Y* |
| 644564 | Y* | Y* | Y* | Y* | Y* | Y* | Y* | Y* |
| 644565 | Y* | Y* | Y* | Y* | Y* | Y* | Y* | Y* |
| 644574 | Y | Y | Y | Y | Y | Y | Y | Y |
| 644575 | Y | Y | Y | Y | Y | Y | Y | Y |
| 644576 | Y | Y | Y | Y | Y | Y | Y | Y |
| 644577 | Y | Y | Y | Y | Y | Y | Y | Y |
| 644578 | Y* | Y* | Y* | Y* | Y* | Y* | Y* | Y* |
| 644579 | Y* | Y* | Y* | Y* | Y* | Y* | Y* | Y* |
| 644795 | Y* | Y* | Y* | Y* | Y* | Y* | Y* | Y* |
| 1375820 | N | N | N | N | N | N | N | N |

*2 & 3 position MTA-100 Posted Connectors can not mate with MTA-100 connectors with polarizing tabs.

MTA-100
.100 [2.54]

Connectors

MTA-100 Posted Connector/Connector Mateability Guide (Continued)

This matrix has been prepared to assist you, our customer, in defining the correct mating halves for the MTA-100 posted connector and connector combination. Where a "Y" is indicated the combination is a valid mating pair. Where an "N" is indicated the combination is not acceptable for mating.

Matrix for .000030
[0.00076] Gold Plated
Part Numbers

| | | Posted Connectors | | | | | | | |
|------------|---------|-------------------|--------|--------|--------|--------|--------|--------|--------|
| | | 647008 | 647009 | 647010 | 647011 | 647012 | 647013 | 647014 | 647015 |
| Connectors | 641237 | Y | Y | Y | Y | Y | Y | Y | Y |
| | 641238 | Y | Y | Y | Y | Y | Y | Y | Y |
| | 641239 | Y | Y | Y | Y | Y | Y | Y | Y |
| | 641240 | Y | Y | Y | Y | Y | Y | Y | Y |
| | 641241 | Y | Y | Y | Y | Y | Y | Y | Y |
| | 641242 | Y | Y | Y | Y | Y | Y | Y | Y |
| | 641243 | Y | Y | Y | Y | Y | Y | Y | Y |
| | 641244 | Y | Y | Y | Y | Y | Y | Y | Y |
| | 644020 | Y* | Y* | Y* | Y* | Y* | Y* | Y* | Y* |
| | 644042 | Y* | Y* | Y* | Y* | Y* | Y* | Y* | Y* |
| | 644043 | Y* | Y* | Y* | Y* | Y* | Y* | Y* | Y* |
| | 644044 | Y* | Y* | Y* | Y* | Y* | Y* | Y* | Y* |
| | 644702 | Y* | Y* | Y* | Y* | Y* | Y* | Y* | Y* |
| | 644726 | Y* | Y* | Y* | Y* | Y* | Y* | Y* | Y* |
| | 1375820 | N | N | N | N | N | N | N | N |

*2 & 3 position MTA-100 Posted Connectors can not mate with MTA-100 connectors with polarizing tabs.

Matrix for .000015
[0.00038] Gold Plated
Part Numbers

| | | Posted Connectors | | | | | | | |
|------------|---------|-------------------|--------|--------|--------|--------|--------|--------|--------|
| | | 647008 | 647009 | 647010 | 647011 | 647012 | 647013 | 647014 | 647015 |
| Connectors | 641190 | Y | Y | Y | Y | Y | Y | Y | Y |
| | 641191 | Y | Y | Y | Y | Y | Y | Y | Y |
| | 641192 | Y | Y | Y | Y | Y | Y | Y | Y |
| | 641193 | Y | Y | Y | Y | Y | Y | Y | Y |
| | 641198 | Y | Y | Y | Y | Y | Y | Y | Y |
| | 641199 | Y | Y | Y | Y | Y | Y | Y | Y |
| | 641200 | Y | Y | Y | Y | Y | Y | Y | Y |
| | 641201 | Y | Y | Y | Y | Y | Y | Y | Y |
| | 644038 | Y* | Y* | Y* | Y* | Y* | Y* | Y* | Y* |
| | 644040 | Y* | Y* | Y* | Y* | Y* | Y* | Y* | Y* |
| | 647477 | Y* | Y* | Y* | Y* | Y* | Y* | Y* | Y* |
| | 647480 | Y* | Y* | Y* | Y* | Y* | Y* | Y* | Y* |
| | 1375820 | N | N | N | N | N | N | N | N |
| | 1744020 | Y* | Y* | Y* | Y* | Y* | Y* | Y* | Y* |

*2 & 3 position MTA-100 Posted Connectors can not mate with MTA-100 connectors with polarizing tabs.

MTA-100 IDC Posted Connectors (Wire-to-Wire)—Closed End, Feed-Thru

Material and Finish

Housing — UL 94V-2 rated, nylon, see chart for color

Contacts — Copper alloy, post tin or gold plated over nickel (see chart)

Notes:

1. Mating half visuals - pages 14 & 15.
2. Use feed thru strain relief covers & feed thru dust covers (if needed) - page 16.
3. Approved wire listing - pages 70 thru 74.

MTA-100
.100 [2.54]



Closed End

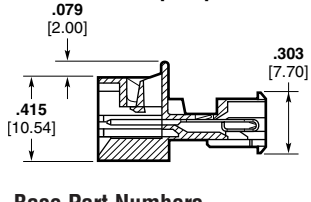

Feed-Thru

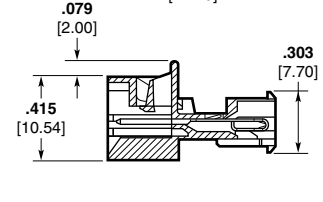
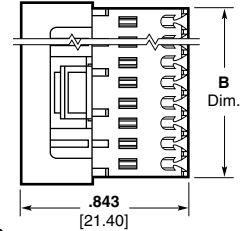

Connector Ordering Information

The "Base Part Numbers" Chart at right shows the base part number.

Prefixes and suffixes are determined by the number of circuit positions in the connector. For example, the complete part number for a 12-position closed end connector for 22 AWG wire would be:

Base number **647000** plus prefix-and-suffix **4-2**

The correct ordering number is **4-647000-2**

All part numbers are the RoHS equivalent version. Example:

| No. of Pos. | Lead Free RoHS Prefix/Suffix |
|-------------|------------------------------|
| 2 | 3-647000-2 |
| | thru |
| 19 | 4-647000-9 |

See page 15 for an explanation of RoHS lead free equivalents.

Note: All RoHS equivalent part numbers may not be available upon catalog release. If the number you need is not available, please contact Product Engineering to expedite your request.

Color Coding by Wire Size for UL 94V-2 Connectors

- 22 AWG — Red
- 24 AWG — White
- 26 AWG — Blue
- 28 AWG — Green

Performance Data

Voltage Rating — 250 VAC

Current Rating — 4 amp max.

Low-Level Resistance — 16 mΩ max. initial

Dielectric Withstanding Voltage — 750 VAC/1 min.

Insulation Resistance — 5000 MΩ min. initial

Operating Temperature —

-55°C to +105°C

Technical Documents

Product Specification
108-1050-1 MTA-100 Posted Connector

Application Specification
114-1019 MTA-100 Connectors

Replacement IDC Contacts

Material and Finish



Base Part Numbers

| Connector Type & Wire Size | Closed End Connector | | Feed-Thru Connector | |
|---------------------------------------------------------|----------------------|--------------------|---------------------|-----------------|
| | Part Nos. | RoHS Equiv. | Part Nos. | No. of Circuits |
| Standard UL 94V-2, Tin Plated | | | | |
| 22 AWG 0.3–0.4 mm ² | 647000 | 32-49 ¹ | 647004 | — ² |
| 24 AWG 0.2 mm ² | 647001 | 32-49 ¹ | 647005 | — ² |
| 26 AWG 0.12–0.15 mm ² | 647002 | 32-49 ¹ | 647006 | — ² |
| 28 AWG 0.08–0.09 mm ² | 647003 | 32-49 ¹ | 647007 | — ² |
| Standard UL 94V-2, .000030 [0.00076] Gold Plated | | | | |
| 22 AWG 0.3–0.4 mm ² | 647008 | 32-49 ¹ | 647012 | — ² |
| 24 AWG 0.2 mm ² | 647009 | 32-49 ¹ | 647013 | — ² |
| 26 AWG 0.12–0.15 mm ² | 647010 | 32-49 ¹ | 647014 | — ² |
| 28 AWG 0.08–0.09 mm ² | 647011 | 32-49 ¹ | 647015 | — ² |
| Standard UL 94V-2, .000015 [0.00038] Gold Plated | | | | |
| 22 AWG 0.3–0.4 mm ² | 647016 | 32-49 ¹ | 647020 | — ² |
| 24 AWG 0.2 mm ² | 647017 | 32-49 ¹ | 647021 | — ² |
| 26 AWG 0.12–0.15 mm ² | 647018 | 32-49 ¹ | 647022 | — ² |
| 28 AWG 0.08–0.09 mm ² | 647019 | 32-49 ¹ | 647023 | — ² |

¹ 2 and 3 position MTA-100 Posted Connectors (Closed End) can not mate with MTA-100 connectors with polarizing tabs.

² Parts may be manufactured upon request. Minimums may apply. Contact product engineer or product manager for details.

| No. of Circuits | Dim. | | No. of Circuits | Dim. | | No. of Circuits | Dim. | |
|-----------------|--------------|--------------|-----------------|---------------|--------------|-----------------|---------------|---------------|
| | A | B | | A | B | | A | B |
| 2 | .300 [7.62] | .227 [5.77] | 6 | .700 [17.78] | .627 [15.93] | 10 | 1.100 [27.94] | 1.027 [26.09] |
| 3 | .400 [10.16] | .327 [8.31] | 7 | .800 [20.32] | .727 [18.47] | 11 | 1.200 [30.48] | 1.127 [28.63] |
| 4 | .500 [12.70] | .427 [10.85] | 8 | .900 [22.86] | .827 [21.01] | 12 | 1.300 [33.02] | 1.227 [31.17] |
| 5 | .600 [15.24] | .527 [13.39] | 9 | 1.000 [25.40] | .927 [23.55] | 13 | 1.400 [35.56] | 1.327 [33.71] |
| | | | | | | 14 | 1.500 [38.10] | 1.427 [36.25] |
| | | | | | | 15 | 1.600 [40.64] | 1.527 [38.79] |
| | | | | | | 16 | 1.700 [43.18] | 1.627 [41.33] |
| | | | | | | 17 | 1.800 [45.72] | 1.727 [43.87] |
| | | | | | | 18 | 1.900 [48.26] | 1.827 [46.41] |
| | | | | | | 19 | 2.000 [50.80] | 1.927 [48.95] |

| Wire Size AWG mm ² | Part Numbers | |
|----------------------------------|--------------|-------------------------------|
| | Tin Plated | .000030 [0.00076] Gold Plated |
| 22 0.3–0.4 | 3-647030-1 | 3-647030-2 |
| 24 0.2 | 3-647031-1 | 3-647031-2 |
| 26 0.12–0.15 | 3-647032-1 | 3-647032-2 |
| 28 0.8–0.9 | 3-647033-1 | 3-647033-2 |

MTA-100 Flat Headers—Straight and Right-Angle

Material and Finish

Housing—UL94V-0 rated, polyester, white

Posts—Copper alloy, tin plated, .000030 [0.00076] or .000015 [0.00038] gold over nickel

Notes:

1. Post(s) can be omitted for keying purposes. Specify the desired post(s) to be omitted using the figure to identify Post No. 1.
2. Gold headers are duplex plated, gold on mating end of post and tin on the solder tail.
3. To determine header overall length (dim. A) multiply .100 x the number of posts. Example: .100 x 10 posts equals 1.000 inch [25.4 mm].

For mateability options, see matrix on pages 12 and 13.

For mating half visuals, see pages 14, 15 and 31.

Header Ordering Information

The “Base Part Numbers” Chart at right shows the base part number.

Prefixes and suffixes are determined by the number of post positions in the header. For example, the complete part number for a 10-position header with straight posts would be:

Base number **641211** plus prefix-and-suffix **4- — 0**

The correct ordering number is **4-641211-0**

All part numbers are the RoHS equivalent version. Example:

| No. of Pos. | Lead Free RoHS Prefix/Suffix |
|-------------|------------------------------|
| 2 | 3-641211-2 |
| | thru |
| 28 | 5-641211-8 |

See page 15 for an explanation of RoHS lead free equivalents.

Note: All RoHS equivalent part numbers may not be available upon catalog release. If the number you need is not available, please contact Product Engineering to expedite your request.

Note: Select load headers (omitted pin headers) are available upon request. Please contact product engineer or product manager for details.

Straight Post (.025 [0.64] Square)



Right-Angle Post (.025 [0.64] Square)



X = .120 [3.05] min., .240 [6.1] max.
when mated with MTA-100 Connector.
X = .120 [3.05] min., when mated with
CST-100 II Connector.



Recommended Mounting Hole Pattern for
.062 [1.57] Thk. PC Board



Recommended Mounting Hole Pattern for
.062 [1.57] Thk. PC Board

Note: Consult Product Drawing for details on placing headers onto PC boards.

Base Part Numbers

| Straight Posts | | Right-Angle Posts | |
|--------------------------------------------------------|--------------------------|-------------------|--------------------------|
| Header Part Nos. | No. of Posts/RoHS Equiv. | Header Part Nos. | No. of Posts/RoHS Equiv. |
| Standard UL94V-0, Tin Plated | | | |
| 640452 | 2-28 | 640453 | 2-28 |
| Standard UL94V-0, .000030 [0.00076] Gold Plated | | | |
| 641211 | 2-28 32-58 | 641212 | 2-28 32-58 |
| Standard UL94V-0, .000015 [0.00038] Gold Plated | | | |
| 641122 | 2-28 32-58 | 641123 | 2-28 32-58 |

MTA-100 Narrow Flat Headers—Straight and Right-Angle

Material and Finish

Housing — UL94V-0 rated, polyester, white

Posts — Copper alloy, tin plated, .000030 [0.00076] or .000015 [0.00038] gold over nickel

Notes:

1. Post(s) can be omitted for keying purposes. Specify the desired post(s) to be omitted using the figure to identify Post No. 1.
2. Headers without retentive legs are suitable for breakaway application.
3. 2 or 3 retentive leg(s) per header, depending upon number of positions.
4. Gold headers are duplex plated, gold on mating end of post and tin on the solder tail.
5. To determine header overall length (dim. A) multiply .100 x the number of posts minus (-) .012. Example: .100 x 10 posts - .012 = .988 inches [25.1 mm].

For mateability options, see matrix on pages 12 and 13. For mating half visuals, see pages 14, 15 and 31.

Connector Ordering Information

The “Base Part Numbers” Chart at right shows the base part number.

Prefixes and suffixes are determined by the number of post positions in the header. For example, the complete part number for a 10-position header with straight posts and without retentive legs would be:

Base number **644456** plus prefix-and-suffix **4- -0**

The correct ordering number is **4-644456-0**

All part numbers are the RoHS equivalent version. Example:

| No. of Pos. | Lead Free RoHS Prefix/Suffix |
|-------------|------------------------------|
| 2 | 3-644456-2 |
| thru | |
| 28 | 5-644456-8 |

See page 15 for an explanation of RoHS lead free equivalents.

Note: All RoHS equivalent part numbers may not be available upon catalog release. If the number you need is not available, please contact Product Engineering to expedite your request.

Note:

Select load headers (omitted pin headers) are available upon request. Please contact product engineer or product manager for details.

Straight Post (.025 [0.64] Square)



Right-Angle Post (.025 [0.64] Square)



Straight and Right-Angle Post with Retentive Legs

Connector Ordering Information

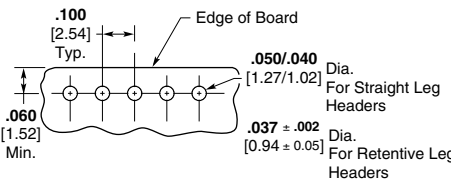

Recommended Mounting Hole Pattern for .062 [1.57] Thk. PC Board

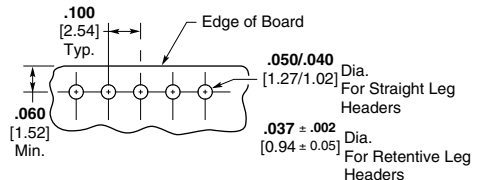

Recommended Mounting Hole Pattern for .062 [1.57] Thk. PC Board

Note: Consult Product Drawing for details on placing headers onto PC boards.

Base Part Numbers

| Straight Posts | | | | Right-Angle Posts | | | |
|--------------------------------------------------------|-------------|---------------------|-------------|------------------------|-------------|---------------------|-------------|
| Without Retentive Legs | | With Retentive Legs | | Without Retentive Legs | | With Retentive Legs | |
| Header Part Nos. | RoHS Equiv. | Header Part Nos. | RoHS Equiv. | Header Part Nos. | RoHS Equiv. | Header Part Nos. | RoHS Equiv. |
| Standard UL94V-0, Tin Plated | | | | | | | |
| 644456 | 32-58 | 644695 | 32-58 | 644457 | 32-58 | 644694 | 32-58 |
| Standard UL94V-0, .000030 [0.00076] Gold Plated | | | | | | | |
| 644884 | 2-28 | 644886 | 2-28 | 644885 | 2-28 | 644887 | 2-28 |
| Standard UL94V-0, .000015 [0.00038] Gold Plated | | | | | | | |
| 644888 | 2-28 | 644890 | 2-28 | 644889 | 2-28 | 644891 | 2-28 |

High temperature product available. Please contact Sales Engineer or Product Information Center.

MTA-100 .100 [2.54]

MTA-100 Polarized Headers—Straight and Right-Angle

Material and Finish

Housing—UL94V-0 rated, polyester, white

Posts—Copper alloy, tin plated, .000030 [0.00076] or .000015 [0.00038] gold over nickel

Notes:

1. Post(s) can be omitted for keying purposes. Specify the desired post(s) to be omitted using the figure to identify Post No. 1.
2. Gold headers are duplex plated, gold on mating end of post and tin on the solder tail.
3. All posts on retentive leg headers are bent.
4. To determine header overall length (dim. A) multiply .100 x the number of posts. Example: .100 x 10 posts equals 1.000 inch [25.4 mm].

For mateability options, see matrix on pages 12 and 13.
For mating half visuals, see pages 14, 15 and 31.

Header Ordering Information

The “Base Part Numbers” Chart at right shows the base part number.

Prefixes and suffixes are determined by the number of post positions in the header. For example, the complete part number for a 10-position header with straight posts would be:

Base number **641213** plus prefix-and-suffix **4- -0**

The correct ordering number is **4-641213-0**

All part numbers are the RoHS equivalent version. Example:

| No. of Pos. | Lead Free RoHS Prefix/Suffix |
|-------------|------------------------------|
| 2 | 3-641213-2 |
| | thru |
| 28 | 5-641213-8 |

See page 15 for an explanation of RoHS lead free equivalents.

Note: All RoHS equivalent part numbers may not be available upon catalog release. If the number you need is not available, please contact Product Engineering to expedite your request.

Note: Select load headers (omitted pin headers) are available upon request. Please contact product engineer or product manager for details.

Straight Post (.025 [0.64] Square)



Right-Angle Post (.025 [0.64] Square)

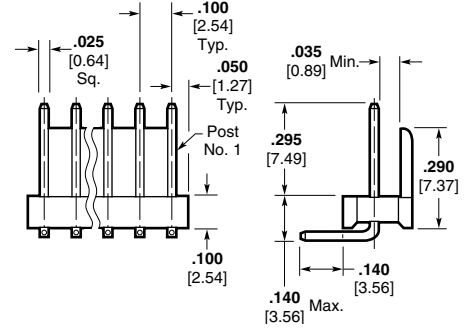
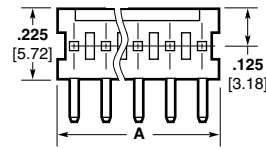

Retentive Leg



Retentive Leg



Recommended Mounting Hole Pattern for .062 [1.57] Thk. PC Board



Recommended Mounting Hole Pattern for .062 [1.57] Thk. PC Board

Note: Consult Product Drawing for details on placing headers onto PC boards.

Base Part Numbers

| Straight Posts | | | | Right-Angle Posts | | | |
|--------------------------------------------------------|-------------|---------------------|-------------|------------------------|-------------|---------------------|-------------|
| Without Retentive Legs | | With Retentive Legs | | Without Retentive Legs | | With Retentive Legs | |
| Header Part Nos. | RoHS Equiv. | Header Part Nos. | RoHS Equiv. | Header Part Nos. | RoHS Equiv. | Header Part Nos. | RoHS Equiv. |
| Standard UL94V-0, Tin Plated | | | | | | | |
| 640454 | 2-28 | 644876 | 2-28 | 640455 | 2-28 | 644877 | 2-28 |
| Standard UL94V-0, .000030 [0.00076] Gold Plated | | | | | | | |
| 641213 | 32-58 | — | — | 641214 | 32-58 | — | — |
| Standard UL94V-0, .000015 [0.00038] Gold Plated | | | | | | | |
| 641124 | 32-58 | — | — | 641125 | 32-58 | — | — |

MTA-100 Friction Lock Headers—Straight and Right-Angle

Material and Finish

Housing—UL94V-0 rated, polyester, white

Posts—Copper alloy, tin plated, .000030 [0.00076] or .000015 [0.00038] gold over nickel

Notes:

1. Post(s) can be omitted for keying purposes. Specify the desired post(s) to be omitted using the figure to identify Post No. 1.
2. Gold headers are duplex plated, gold on mating end of post and tin on the solder tail.
3. All posts on retentive leg headers are bent.
4. To determine header overall length (dim. A) multiply .100 x the number of posts. Example: .100 x 10 posts equals 1.000 inch [25.4 mm].

For mateability options, see matrix on pages 12 and 13.

For mating half visuals, see pages 14, 15 and 31.

Header Ordering Information

The “Base Part Numbers” Chart at right shows the base part number.

Prefixes and suffixes are determined by the number of post positions in the header. For example, the complete part number for a 10-position header with straight posts would be:

Base number **641215** plus prefix-and-suffix **4- -0**

The correct ordering number is **4-641215-0**

All part numbers are the RoHS equivalent version. Example:

| No. of Pos. | Standard Prefix/Suffix | Lead Free RoHS Prefix/Suffix |
|-------------|------------------------|------------------------------|
| 2 | 641215-2 | 3-641215-2 |
| thru | | |
| 28 | 2-641215-8 | 5-641215-8 |

See page 15 for an explanation of RoHS lead free equivalents.

Note: All RoHS equivalent part numbers may not be available upon catalog release. If the number you need is not available, please contact Product Engineering to expedite your request.

Note: Select load headers (omitted pin headers) are available upon request. Please contact product engineer or product manager for details.

Straight Post (.025 [0.64] Square)



Right-Angle Post (.025 [0.64] Square)

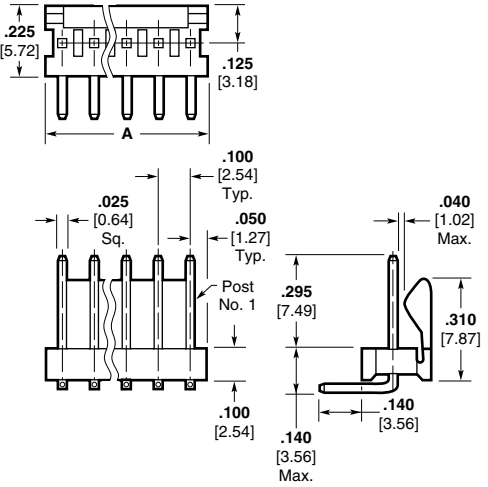

Note: Consult Product Drawing for details on placing headers onto PC boards.

Base Part Numbers

| Straight Posts | | | | Right-Angle Posts | | | |
|--------------------------------------------------------|-------------|---------------------|-------------|------------------------|-------------|---------------------|-------------|
| Without Retentive Legs | | With Retentive Legs | | Without Retentive Legs | | With Retentive Legs | |
| Header Part Nos. | RoHS Equiv. | Header Part Nos. | RoHS Equiv. | Header Part Nos. | RoHS Equiv. | Header Part Nos. | RoHS Equiv. |
| Standard UL94V-0, Tin Plated | | | | | | | |
| 640456 | 2-28 | 644874 | 2-28 | 640457 | 2-28 | 644875 | 2-28 |
| Standard UL94V-0, .000030 [0.00076] Gold Plated | | | | | | | |
| 641215 | 32-58 | — | — | 641216 | 32-58 | — | — |
| Standard UL94V-0, .000015 [0.00038] Gold Plated | | | | | | | |
| 641126 | 32-58 | — | — | 641127 | 32-58 | — | — |

MTA-100 .100 [2.54]

MTA-100 Headers with Retention Peg—Straight

Material and Finish

Housing—UL94V-0 rated, thermo-plastic, black

Posts—Copper alloy, tin plated, .000030 [0.00076] or .000015 [0.00038] gold over nickel

Notes:

1. Post(s) can be omitted for keying purposes. Specify the desired post(s) to be omitted using the figure to identify Post No. 1.
2. Gold headers are duplex plated, gold on mating end of post and tin on the solder tail.
3. To determine header overall length (dim. A) multiply .100 x the number of posts. Example: .100 x 10 posts equals 1.000 inch [25.4 mm].

For mateability options, see matrix on pages 12 and 13.

For mating half visuals, see pages 14, 15 and 31.

Header Ordering Information

The “Base Part Numbers” Chart at right shows the base part number.

Prefixes and suffixes are determined by the number of post positions in the header. For example, the complete part number for a 10-position header with straight posts would be:

Base number **647609** plus prefix-and-suffix
4- -0

The correct ordering number is **4-647609-0**

All part numbers are the RoHS equivalent version. Example:

| No. of Pos. | Standard Prefix/Suffix | Lead Free RoHS Prefix/Suffix |
|-------------|------------------------|------------------------------|
| 2 | 647609-2 | 3-647609-2 |
| 3 | 647609-3 | 3-647609-3 |
| 4 | 647609-4 | 3-647609-4 |
| 5 | 647609-5 | 3-647609-5 |
| 6 | 647609-6 | 3-647609-6 |
| 7 | 647609-7 | 3-647609-7 |
| 8 | 647609-8 | 3-647609-8 |
| 9 | 647609-9 | 3-647609-9 |
| 10 | 1-647609-0 | 4-647609-0 |
| 11 | 1-647609-1 | 4-647609-1 |
| 12 | 1-647609-2 | 4-647609-2 |

Note: All RoHS equivalent part numbers may not be available upon catalog release. If the number you need is not available, please contact Product Engineering to expedite your request.

Friction Lock



Polarized



Recommended Mounting Hole Pattern for .062 [1.57] Thk. PC Board

Note: Consult Product Drawing for details on placing headers onto PC boards.

Base Part Numbers

| Friction Lock | | Polarized | |
|--------------------------------------------------------|-------------|------------------|-------------|
| Header Part Nos. | RoHS Equiv. | Header Part Nos. | RoHS Equiv. |
| Standard UL94V-0, Tin Plated | | | |
| 647609 | 32-42 | 647623 | 32-42 |
| Standard UL94V-0, .000030 [0.00076] Gold Plated | | | |
| 647626 | 32-42 | 647624 | 32-42 |
| Standard UL94V-0, .000015 [0.00038] Gold Plated | | | |
| 647627 | 32-42 | 647625 | 32-42 |

Note:

Select load headers (omitted pin headers) are available upon request. Please contact product engineer or product manager for details.

MTA-100 High Profile Headers—Right-Angle

Material and Finish

Housing—UL94V-0 rated, thermo-plastic, black

Posts—Copper alloy, tin plated, .000030 [0.00076] or .000015 [0.00038] gold over nickel

Notes:

1. Post(s) can be omitted for keying purposes. Specify the desired post(s) to be omitted using the figure to identify Post No. 1.
2. Gold headers are duplex plated, gold on mating end of post and tin on the solder tail.
3. To determine header overall length (dim. A) multiply .100 x the number of posts. Example: .100 x 10 posts equals 1.000 inch [25.4 mm].
4. This product can be mounted in the middle of the PC Board as shown in the PCB layout.

For mateability options, see matrix on pages 12 and 13.

For mating half visuals, see pages 14, 15 and 31.

Header Ordering Information

The "Base Part Numbers" Chart at right shows the base part number.

Prefixes and suffixes are determined by the number of post positions in the header. For example, the complete part number for a 10-position header with right-angle posts would be:

Base number **647630** plus prefix-and-suffix
4- -0

The correct ordering number is **4-647630-0**

All part numbers are the RoHS equivalent version. Example:

| No. of Pos. | Lead Free RoHS Prefix/Suffix |
|-------------|------------------------------|
| 2 | 3-647630-2 |
| 3 | 3-647630-3 |
| 4 | 3-647630-4 |
| 5 | 3-647630-5 |
| 6 | 3-647630-6 |
| 7 | 3-647630-7 |
| 8 | 3-647630-8 |
| 9 | 3-647630-9 |
| 10 | 4-647630-0 |
| 11 | 4-647630-1 |
| 12 | 4-647630-2 |

Note: All RoHS equivalent part numbers may not be available upon catalog release. If the number you need is not available, please contact Product Engineering to expedite your request.

Friction Lock

Right-Angle Post (.025 [0.64] Square)



Polarized

Right-Angle Post (.025 [0.64] Square)



Recommended Mounting Hole Pattern for .062 [1.57] Thk. PC Board

Note: Consult Product Drawing for details on placing headers onto PC boards.

Base Part Numbers

| Friction Lock | | Polarized | |
|--------------------------------------------------------|-------------|-------------------|-------------|
| Right-Angle Posts | | Right-Angle Posts | |
| Header Part Nos. | RoHS Equiv. | Header Part Nos. | RoHS Equiv. |
| Standard UL94V-0, Tin Plated | | | |
| 647630 | 32-42 | 647651 | 32-42 |
| Standard UL94V-0, .000030 [0.00076] Gold Plated | | | |
| 647629 | 32-42 | 647653 | 32-42 |
| Standard UL94V-0, .000015 [0.00038] Gold Plated | | | |
| 647628 | 32-42 | 647652 | 32-42 |

Note:

Select load headers (omitted pin headers) are available upon request. Please contact product engineer or product manager for details.

MTA-100
.100 [2.54]

MTA-100 Polarized High Temperature Headers—Straight and Right-Angle

Material and Finish

Housing —

2–12 Position — UL94V-0 rated,
nylon, black
13–18 Position — UL94V-0 rated,
LCP, black

Posts—Copper alloy, tin plated,
.000030 [0.00076] or .000015
[0.00038] gold over nickel

Notes:

1. Post(s) can be omitted for keying purposes. Specify the desired post(s) to be omitted using the figure to identify Post No. 1.
2. Gold headers are duplex plated, gold on mating end of post and tin on the solder tail.
3. To determine header overall length (dim. A) multiply .100 x the number of posts. Example: .100 x 10 posts equals 1.000 inch [25.4 mm].

For mateability options, see matrix on pages 12 and 13.

For mating half visuals, see pages 14, 15 and 31.

Header Ordering Information

The “Base Part Numbers” Chart at right shows the base part number.

Prefixes and suffixes are determined by the number of post positions in the header. For example, the complete part number for a 10-position header with straight posts would be:

Base number **647047** plus
prefix-and-suffix
4- -0

The correct ordering number is
4-647047-0

All part numbers are the RoHS equivalent version. Example:

| No. of Pos. | Lead Free RoHS Prefix/Suffix |
|-------------|------------------------------|
| 2 | 3-647047-2 |
| | thru |
| 12 | 4-647047-2 |
| 13 | NA |
| | thru |
| 18 | NA |

See page 15 for an explanation of RoHS lead free equivalents.

Note: All RoHS equivalent part numbers may not be available upon catalog release. If the number you need is not available, please contact Product Engineering to expedite your request.

For use with Infrared Reflow Process

Maximum Temperature Rating: 2–12 Position: 280°C
13–18 Position: 235°C

Straight Post (.025 [0.64] Square)



Right-Angle Post (.025 [0.64] Square)

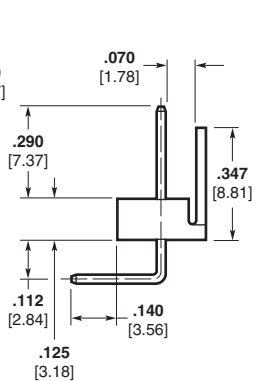

Recommended Mounting Hole Pattern for .062 [1.57] Thick PC Board

Note: Consult Product Drawing for details on placing headers onto PC boards.

Base Part Numbers

| Straight Posts | | Straight Posts (Tube Loaded) | | Right-Angle Posts | |
|--------------------------------------------------------|-------------|------------------------------|-------------|-------------------|-------------|
| Header Part Nos. | RoHS Equiv. | Header Part Nos. | RoHS Equiv. | Header Part Nos. | RoHS Equiv. |
| Standard UL94V-0, Tin Plated | | | | | |
| 647047 | 32-42 | 647298 | 32-42 | 647048 | 32-42 |
| Standard UL94V-0, .000030 [0.00076] Gold Plated | | | | | |
| 647109 | 32-42 | 647300 | 32-42 | 647114 | 32-42 |
| Standard UL94V-0, .000015 [0.00038] Gold Plated | | | | | |
| 647075 | 32-42 | 647299 | 32-42 | 647076 | 32-42 |

Note: Select load headers (omitted pin headers) are available upon request. Please contact product engineer or product manager for details.

MTA-100 Friction Lock High Temperature Headers—Straight and Right-Angle

Material and Finish

Housing —
 2–12 Position — UL94V-0 rated, nylon, black
 13–18 Position — UL94V-0 rated, LCP, black

Posts — Copper alloy, tin plated, .000030 [0.00076] or .000015 [0.00038] gold over nickel

Notes:

1. Post(s) can be omitted for keying purposes. Specify the desired post(s) to be omitted using the figure to identify Post No. 1.
2. Gold headers are duplex plated, gold on mating end of post and tin on the solder tail.
3. To determine header overall length (dim. A) multiply .100 x the number of posts. Example: .100 x 10 posts equals 1.000 inch [25.4 mm].

For mateability options, see matrix on pages 12 and 13.
 For mating half visuals, see pages 14, 15 and 31.

Header Ordering Information

The “Base Part Numbers” Chart at right shows the base part number.

Prefixes and suffixes are determined by the number of post positions in the header. For example, the complete part number for a 10-position header with straight posts would be:

Base number **647050** plus prefix-and-suffix **4- -0**

The correct ordering number is **4-647050-0**

All part numbers are the RoHS equivalent version. Example:

| No. of Pos. | Standard Prefix/Suffix | Lead Free RoHS Prefix/Suffix |
|-------------|------------------------|------------------------------|
| 2 | 647050-2 | 3-647050-2 |
| thru | | |
| 12 | 1-647050-2 | 4-647050-2 |
| 13 | 1-647050-3 | NA |
| thru | | |
| 18 | 1-647050-8 | NA |

See page 15 for an explanation of RoHS lead free equivalents.

Note: All RoHS equivalent part numbers may not be available upon catalog release. If the number you need is not available, please contact Product Engineering to expedite your request.

For use with Infrared Reflow Process

Maximum Temperature Rating: 2–12 Position: 280°C
 13–18 Position: 235°C

Straight Post (.025 [0.64] Square)

Right-Angle Post (.025 [0.64] Square)

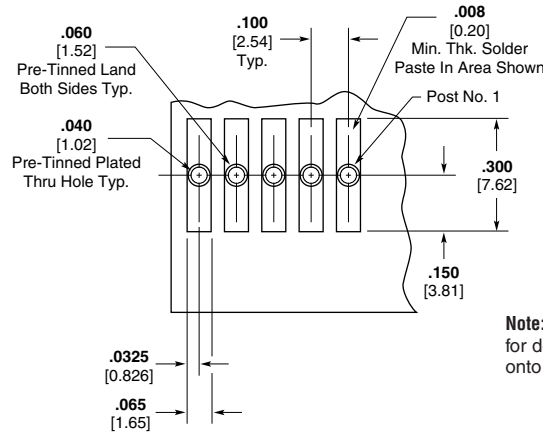
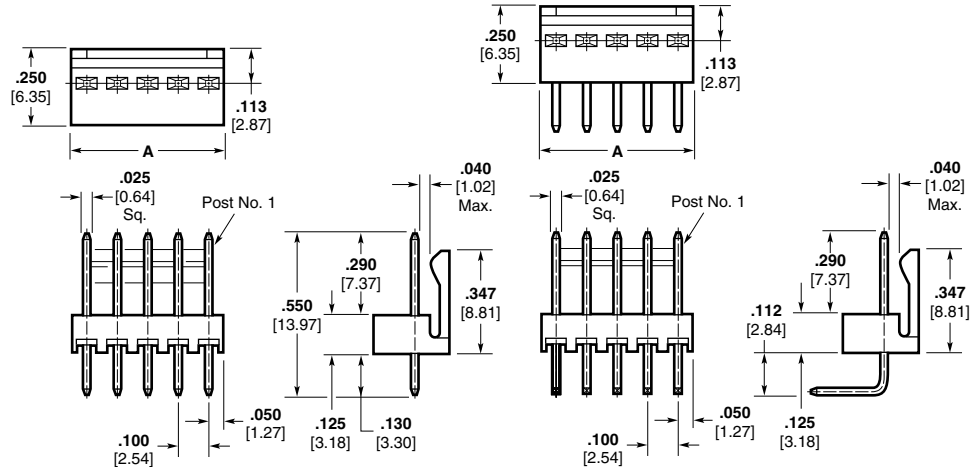

Note: Consult Product Drawing for details on placing headers onto PC boards.

Recommended Mounting Hole Pattern for .062 [1.57] Thick PC Board

Base Part Numbers

| Straight Posts | | Straight Posts (Tube Loaded) | | Right-Angle Posts | |
|--------------------------------------------------------|-------------|------------------------------|-------------|-------------------|-------------|
| Header Part Nos. | RoHS Equiv. | Header Part Nos. | RoHS Equiv. | Header Part Nos. | RoHS Equiv. |
| Standard UL94V-0, Tin Plated | | | | | |
| 647050 | 32-42 | 647295 | 32-42 | 647051 | 32-42 |
| Standard UL94V-0, .000030 [0.00076] Gold Plated | | | | | |
| 647116 | 32-42 | 647297 | 32-42 | 647117 | 32-42 |
| Standard UL94V-0, .000015 [0.00038] Gold Plated | | | | | |
| 647078 | 32-42 | 647296 | 32-42 | 647079 | 32-42 |

Note: Select load headers (omitted pin headers) are available upon request. Please contact product engineer or product manager for details.

MTA-100
 .100 [2.54]

MTA-100 Polarized and Friction Lock Surface Mount Headers—Straight

Material and Finish

Housing —

2–12 Position — UL94V-0 rated, nylon, black
13–18 Position — UL94V-0 rated, LCP, black

Posts — Copper alloy, tin plated, .000030 [0.00076] or .000015 [0.00038] gold over nickel

Notes:

1. Post(s) can be omitted for keying purposes. Specify the desired post(s) to be omitted using the figure to identify Post No. 1.
2. Gold headers are duplex plated, gold on mating end of post and tin on the solder tail.
3. To determine header overall length (dim. A) multiply .100 x the number of posts. Example: .100 x 10 posts equals 1.000 inch [25.4 mm].

For mateability options, see matrix on pages 12 and 13.

For mating half visuals, see pages 14, 15 and 31.

Header Ordering Information

The “Base Part Numbers” Chart at right shows the base part number.

Prefixes and suffixes are determined by the number of post positions in the header. For example, the complete part number for a 10-position surface mount polarized header would be:

Base number **647106** plus prefix-and-suffix
4- -0

The correct ordering number is **4-647106-0**

All part numbers are the RoHS equivalent version. Example:

| No. of Pos. | Lead Free RoHS Prefix/Suffix |
|-------------|------------------------------|
| 2 | 3-647106-2 |
| 12 | 4-647106-2 |

See page 15 for an explanation of RoHS lead free equivalents.

Note: All RoHS equivalent part numbers may not be available upon catalog release. If the number you need is not available, please contact Product Engineering to expedite your request.

For use with Infrared Reflow Process

Maximum Temperature Rating: 2–12 Position: 280°C
13–18 Position: 235°C

Polarized Header



Friction Lock Header



Note: Consult Product Drawing for details on placing headers onto PC boards.

Recommended PC Board Layout for use with .010 [0.25] Thick Stencil

Base Part Numbers

| Polarized Headers | | Friction Lock Headers | |
|--------------------------------------------------------|-------------|-----------------------|-------------|
| Header Part Nos. | RoHS Equiv. | Header Part Nos. | RoHS Equiv. |
| Standard UL94V-0, Tin Plated | | | |
| 647106 | 32-42 | 647166 | 32-42 |
| Standard UL94V-0, .000030 [0.00076] Gold Plated | | | |
| 647108 | 32-42 | 647168 | 32-42 |
| Standard UL94V-0, .000015 [0.00038] Gold Plated | | | |
| 647107 | 32-42 | 647167 | 32-42 |

Tape Mount Part Numbers

| Polarized Headers | | Friction Lock Headers | |
|--------------------------------------------------------|-------------|-----------------------|-------------|
| Header Part Nos. | RoHS Equiv. | Header Part Nos. | RoHS Equiv. |
| Standard UL94V-0, Tin Plated | | | |
| 647531 | 32-42 | 647502 | 32-42 |
| Standard UL94V-0, .000030 [0.00076] Gold Plated | | | |
| | | 1744163 | 32-42 |
| Standard UL94V-0, .000015 [0.00038] Gold Plated | | | |
| | | 647467 | 32-42 |

Note: Select load headers (omitted pin headers) are available upon request. Please contact product engineer or product manager for details.

MTA-100
.100 [2.54]

MTA-100 Shrouded Headers—Straight and Right-Angle

Material and Finish

Housing—UL94V-0 rated, polyester, black

Posts—Copper alloy, tin plated; or .000030 [0.00076] gold over nickel

Notes:

1. Post(s) can be omitted for keying purposes. Specify the desired post(s) to be omitted using the figure to identify Post No. 1.
2. Headers with .000015 [0.00038] gold plated post are available upon request. Minimums may apply.
3. Gold headers are duplex plated, gold on mating end of post and tin on the solder tail.

For mateability options, see matrix on pages 12 and 13.
For mating half visuals, see pages 14 and 15.

Header Ordering Information

The “Base Part Numbers” Chart at right shows the base part number.

Prefixes and suffixes are determined by the number of post positions in the header. For example, the complete part number for a 10-position header with straight posts and with pegs would be:

Base number **644486** plus prefix-and-suffix **4- -0**

The correct ordering number is **4-644486-0**

See page 15 for an explanation of RoHS lead free equivalents.

Note: All RoHS equivalent part numbers may not be available upon catalog release. If the number you need is not available, please contact Product Engineering to expedite your request.

Notes:

1. Select load headers (omitted pin headers) are available upon request. Please contact product engineer or product manager for details.
2. MTA-100 shrouded headers do not mate with CST-100 II housings.

Header Length

| No. of Circuits | Dim. A | Prefix/Suffix |
|-----------------|---------------|---------------|
| 2 | .284 7.21 | 3- -2 |
| 3 | .384 9.75 | 3- -3 |
| 4 | .484 12.29 | 3- -4 |
| 5 | .584 14.83 | 3- -5 |

Straight Post (.025 [0.64] Square)



Right-Angle (.025 [0.64] Square)

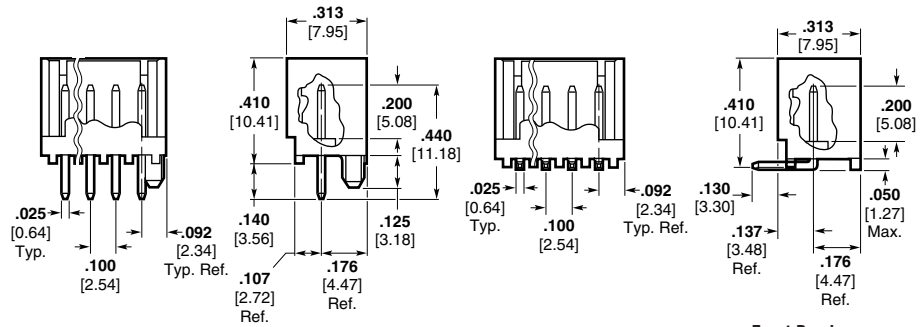

Recommended Mounting Hole Pattern for .125 [3.18] Thk. PC Board (Solder Side of Board Shown)



Recommended Mounting Hole Pattern for .062 [1.57] Thk. PC Board (Solder Side of Board Shown)

Front Bend

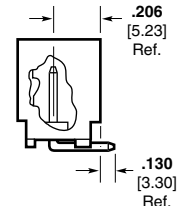

Rear Bend

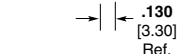

Note: Consult Product Drawing for details on placing headers onto PC boards.

Base Part Numbers

| Straight Posts | | | | Right-Angle Posts | | | |
|--------------------------------------------------------|-------------|------------------|-------------|-----------------------------|-------------|----------------------------|-------------|
| With Pegs | | Without Pegs | | Without Pegs Only | | | |
| Header Part Nos. | RoHS Equiv. | Header Part Nos. | RoHS Equiv. | Front Bend Header Part Nos. | RoHS Equiv. | Rear Bend Header Part Nos. | RoHS Equiv. |
| Standard UL94V-0, Tin Plated | | | | | | | |
| 644486 | 22-34 | 644861 | 22-34 | 644488 | 22-34 | 644803 | 22-34 |
| Standard UL94V-0, .000030 [0.00076] Gold Plated | | | | | | | |
| 644487 | 22-34 | — | — | 644489 | 22-34 | — | — |

.100 [2.54] Centerline CST-100 II Crimp Contacts and Housings

Product Facts

- Low cost wire-to-board interconnections
- Wide wire range for single contact
- Tin and gold plated contacts
- Mates with specified MTA and similar competitive notched headers
- Plastic latching feature in housing helps prevent contact backout
- Locking ramps and polarizing tabs are standard
- For keying purposes use keying plug 641994-1 (page 17)
- Recognized under the Component Program of Underwriters Laboratories Inc., File No. E28476
- Certified by Canadian Standards Association, File No. LR7189

For mateability options, see matrix on pages 12 and 13.

For mating half visuals, see pages 21 thru 29 and 32.

See page 15 for an explanation of RoHS lead free equivalents.

Performance Data

Voltage Rating — 250 vac

Current Rating — 4 amp max.

Low-Level Resistance — 6 mΩ max. initial; 10 mΩ max. final

Insulation Resistance — 1000 MΩ min. initial; 100 MΩ min. final

Operating Temperature — -55° C to +105° C

Technical Documents

Product Specification
108-1948

Application Specification
114-13036

Instruction Sheet
408-8493



Contacts

| Part Numbers | | |
|-------------------------|-------------------------|-------------------------|
| Tin Plated | 15 Au Gold Plated | 30 Au Gold Plated |
| 1375819-1 (Strip) | 1375819-2 (Strip) | 1375819-3 (Strip) |
| 1445336-1 (Loose Piece) | 1445336-2 (Loose Piece) | 1445336-3 (Loose Piece) |

Material and Finish (RoHS Compliant)

Phosphor bronze, pretinned or .000015 [.00038] gold, over nickel
.000030 [0.00076] gold over nickel

Wire Range — 22–26 AWG [0.35–0.13 mm²]

Max. Ins. Dia. — .065 [1.65]

Housing*

Material (RoHS Compliant)

UL94V-0 rated, nylon, white

| No. of Pos. | Dim. A | Part Numbers | No. of Pos. | Dim. A | Part Numbers |
|-------------|----------------|--------------|-------------|----------------|--------------|
| 2 | .220 5.59 | 1375820-2 | 16 | 1.620 41.15 | 1-1375820-6 |
| 3 | .320 8.13 | 1375820-3 | 17 | 1.720 43.69 | 1-1375820-7 |
| 4 | .420 10.67 | 1375820-4 | 18 | 1.820 46.23 | 1-1375820-8 |
| 5 | .520 13.21 | 1375820-5 | 19 | 1.920 48.77 | 1-1375820-9 |
| 6 | .620 15.75 | 1375820-6 | 20 | 2.020 51.31 | 2-1375820-0 |
| 7 | .720 18.29 | 1375820-7 | 21 | 2.120 53.85 | 2-1375820-1 |
| 8 | .820 20.83 | 1375820-8 | 22 | 2.220 56.39 | 2-1375820-2 |
| 9 | .920 23.37 | 1375820-9 | 23 | 2.320 58.93 | 2-1375820-3 |
| 10 | 1.020 25.91 | 1-1375820-0 | 24 | 2.420 61.47 | 2-1375820-4 |
| 11 | 1.120 28.45 | 1-1375820-1 | 25 | 2.520 64.01 | 2-1375820-5 |
| 12 | 1.220 30.99 | 1-1375820-2 | 26 | 2.620 66.55 | 2-1375820-6 |
| 13 | 1.320 33.53 | 1-1375820-3 | 27 | 2.720 69.09 | 2-1375820-7 |
| 14 | 1.420 36.07 | 1-1375820-4 | 28 | 2.820 71.63 | 2-1375820-8 |
| 15 | 1.520 38.61 | 1-1375820-5 | | | |

Application Tooling

Loose Piece Contacts —

Hand Tool No. 58517-3 (408-4064)

Strip Contacts —

AMP-O-LECTRIC Model "G"

Termination Machine*

Applicator No. 567373-3

(Request Catalog 65828)

AMP-O-MATIC Stripper-Crimper

Machine* Applicator No. 567910-1 or

567827-1 (with QQM) (Request Catalog 65004)

AMPOMATOR CLS IIIG Lead Making

Machine* (Request Catalog 82659)

*Requires applicators. For part numbers, call Technical Support.



*Housings without polarizing tabs may be manufactured upon request. Minimums may apply. Contact product engineering or product manager for details.

CST-100 II Shrouded Headers—Straight and Right-Angle

Material and Finish

Housing—UL94V-0 rated, polyester, black

Posts—Copper alloy, tin plated; or .000030 [0.00076] gold over nickel

Notes:

1. Post(s) can be omitted for keying purposes. Specify the desired post(s) to be omitted using the figure to identify Post No. 1.
2. Headers with .000015 [0.00038] gold plated posts are available upon request. Minimums may apply.
3. Gold headers are duplex plated, gold on mating end of post and tin on the solder tail.

For mateability options, see matrix on pages 12 and 13.

For mating half visuals, see page 31.

Header Ordering Information

The “Base Part Numbers” Chart at right shows the base part number and number of posts available for the described headers.

Prefixes and suffixes are determined by the number of post positions in the header. For example, the complete part number for a 10-position header with straight posts and with pegs would be:

Base number **644893** plus prefix-and-suffix **4- -0**

The correct ordering number is **4-644893-0**

All part numbers are the RoHS equivalent version. Example:

| No. of Pos. | Lead Free RoHS Prefix/Suffix |
|-------------|------------------------------|
| 2 | 3-644893-2 |
| | thru |
| 14 | 4-644893-4 |

See page 15 for an explanation of RoHS lead free equivalents.

Note: All RoHS equivalent part numbers may not be available upon catalog release. If the number you need is not available, please contact Product Engineering to expedite your request.

Note:

CST-100 II shrouded headers **only** mate with CST-100 II housings. All the MTA-100 headers except the MTA-100 shrouded headers mate with CST-100 II housings.

Straight Post (.025 [0.64] Square)

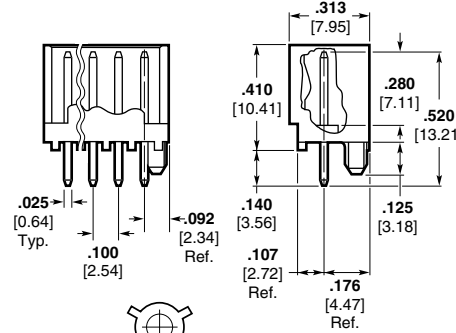

Recommended Mounting Hole Pattern for .062 [1.57] Thk. PC Board (Solder Side of Board Shown)

Right-Angle (.025 [0.64] Square)



Note: Consult Product Drawing for details on placing headers onto PC boards.



Recommended Mounting Hole Pattern for .062 [1.57] Thk. PC Board (Solder Side of Board Shown)

Base Part Numbers

| Straight Posts | | | | Right-Angle Posts Without Pegs Only | |
|--------------------------------------------------------|--------------------------|------------------|--------------------------|-------------------------------------|--------------------------|
| With Pegs | | Without Pegs | | Header Part Nos. | No. of Posts/RoHS Equiv. |
| Header Part Nos. | No. of Posts/RoHS Equiv. | Header Part Nos. | No. of Posts/RoHS Equiv. | | |
| Standard UL94V-0, Tin Plated | | | | | |
| 644893 | 32-44 | 644892 | 32-44 | 644894 | 32-44 |
| Standard UL94V-0, .000030 [0.00076] Gold Plated | | | | | |
| 644897 | 32-44 | 644896 | 32-44 | 644898 | 32-44 |

Header Length

| No. of Circuits | Dim. A | Prefix/Suffix | No. of Circuits | Dim. A | Prefix/Suffix | No. of Circuits | Dim. A | Prefix/Suffix |
|-----------------|---------------|---------------|-----------------|---------------|---------------|-----------------|----------------|---------------|
| 2 | .284 7.21 | 3- -2 | 5 | .584 14.83 | 3- -5 | 8 | .884 22.45 | 3- -8 |
| 3 | .384 9.75 | 3- -3 | 6 | .684 17.37 | 3- -6 | 9 | .984 24.99 | 3- -9 |
| 4 | .484 12.29 | 3- -4 | 7 | .784 19.91 | 3- -7 | 10 | 1.084 27.53 | 4- -0 |

CST-100 II
.100 [2.54]

.156 [3.96] Centerline MTA-156 IDC Connectors and Headers

Product Facts

- Connectors and headers for 2 through 24 positions; wire sizes of 18, 20, 22, 24 and 26 AWG [0.9–0.12 mm²]
- Connectors and headers, except shrouded headers, are end-to-end stackable
- Quad Connectors for higher current rating (page 54)
- Posted connectors for 2, 3, 4, 6, 9, 12, 15 and 24 positions
- Card edge connectors for 3, 6, 9, 12, 15, 18 and 20 through 24 positions
- Connectors preloaded with IDC contacts
- All contacts are slotted for insulation displacement (IDC) termination technique
- Connector styles include both closed end and feed-thru, with and without locking ramps and polarizing tabs
- Molded ribs on housing do not allow reverse mating
- Contacts are lubricated for fretting corrosion protection
- Benefits derived from the MTA-156 system include increases quality and ease of handling such as —
 - One-step assembly
 - No wire stripping
 - No contact damage
 - Reduced wiring errors
 - Simpler tooling
 - Simple maintenance and repair
- Meets the material requirements of Table 23.1 of UL 1410 Standards for Television Receiver and Video Products (wire-to-post connectors only)
- Recognized under the Component Program of Underwriters Laboratories Inc.,  File No. E28476
- Certified by Canadian Standards Association,  File No. LR7189



MTA-156 connectors accept discrete and ribbon cable wire sizes ranging from 18–26 AWG [0.9–0.12 mm²] with maximum insulation outside diameter .095 [2.41] for single wire and .070 [1.78] for mass termination of wires. Tin plated solid, fused stranded or stranded (7, 16, and 19 strands) wire with PVC insulation can be used on 18 AWG [0.8–0.9 mm²] MTA-156 connectors; 7, 10, and 19 stranded wire on 20 AWG [0.5–0.6 mm²] MTA-156 connectors; and 7 and 19 stranded wire on 22–26 AWG [0.4–0.12 mm²] MTA-156 connectors.

Only one wire to be terminated into an IDC contact slot.

Mass termination of wire provides the lowest applied cost because it drastically reduces the labor content of virtually any cable or harness assembly required.

The wire-to-post connector housing material is flame retardant thermoplastic, either UL94V-2 or UL94V-0 rated.

A full line of .156 [3.96] centerline headers completes the system. Headers are available with straight or right-angle posts, in flat friction lock and shrouded styles. Headers are available in 2 through 24 positions.

Note: Refer to page 70 for approved wire listings.

Performance Data*

Voltage Rating—600 vac

Current Rating—
7 amp max. for MTA-156 Connector

Low-Level Resistance—
3.0 mΩ max. initial

Dielectric Withstanding Voltage—
2200 vac/1 min.

Insulation Resistance—
5000 MΩ min. initial

Operating Temperature—
–55° C to +105° C

*Refer to the Product Specification for additional electrical, mechanical and environmental performance tests and requirements.

Technical Documents

Product Specification

108-1051 MTA-156 Connectors

Application Specifications

114-1020 MTA-156 Connectors, Posted Connectors and Card Edge Connectors

114-1032 MTA-156 Ribbon Cable Assembly

MTA-156 Connector/Header Mateability Guide (Continued)

This matrix has been prepared to assist you, our customer, in defining the correct mating halves for the MTA-156 header and connector combination. Where a "Y" is indicated the combination is a valid mating pair. Where an "N" is indicated the combination is not acceptable for mating.

Matrix for .000030
[0.00076] Gold Plated
Part Numbers

| Connectors | Headers | | | | | | | | | | | | | | | |
|------------|---------|--------|--------|--------|--------|--------|--------|--------|--------|--------|--------|--------|--------|--------|--------|--------|
| | 641202 | 641203 | 641204 | 641207 | 641208 | 641209 | 641210 | 641210 | 641210 | 641210 | 641210 | 641210 | 641210 | 641210 | 641210 | 641210 |
| 641217 | Y | Y | Y | N | Y | Y | Y | Y | Y | Y | Y | Y | Y | Y | Y | Y |
| 641218 | Y | Y | Y | N | Y | Y | Y | Y | Y | Y | Y | Y | Y | Y | Y | Y |
| 641219 | Y | Y | Y | N | Y | Y | Y | Y | Y | Y | Y | Y | Y | Y | Y | Y |
| 641220 | Y | Y | Y | N | Y | Y | Y | Y | Y | Y | Y | Y | Y | Y | Y | Y |
| 641221 | Y | Y | Y | N | Y | Y | Y | Y | Y | Y | Y | Y | Y | Y | Y | Y |
| 641222 | Y | Y | Y | Y | Y | Y | Y | Y | Y | Y | Y | Y | Y | Y | Y | Y |
| 641223 | Y | Y | Y | Y | Y | Y | Y | Y | Y | Y | Y | Y | Y | Y | Y | Y |
| 641224 | Y | Y | Y | Y | Y | Y | Y | Y | Y | Y | Y | Y | Y | Y | Y | Y |
| 641225 | Y | Y | Y | Y | Y | Y | Y | Y | Y | Y | Y | Y | Y | Y | Y | Y |
| 641226 | Y | Y | Y | Y | Y | Y | Y | Y | Y | Y | Y | Y | Y | Y | Y | Y |
| 641227 | Y | Y | Y | N | Y | Y | Y | Y | Y | Y | Y | Y | Y | Y | Y | Y |
| 641228 | Y | Y | Y | N | Y | Y | Y | Y | Y | Y | Y | Y | Y | Y | Y | Y |
| 641229 | Y | Y | Y | N | Y | Y | Y | Y | Y | Y | Y | Y | Y | Y | Y | Y |
| 641230 | Y | Y | Y | N | Y | Y | Y | Y | Y | Y | Y | Y | Y | Y | Y | Y |
| 641231 | Y | Y | Y | N | Y | Y | Y | Y | Y | Y | Y | Y | Y | Y | Y | Y |
| 641232 | Y | Y | Y | Y | Y | Y | Y | Y | Y | Y | Y | Y | Y | Y | Y | Y |
| 641233 | Y | Y | Y | Y | Y | Y | Y | Y | Y | Y | Y | Y | Y | Y | Y | Y |
| 641234 | Y | Y | Y | Y | Y | Y | Y | Y | Y | Y | Y | Y | Y | Y | Y | Y |
| 641235 | Y | Y | Y | Y | Y | Y | Y | Y | Y | Y | Y | Y | Y | Y | Y | Y |
| 641236 | Y | Y | Y | Y | Y | Y | Y | Y | Y | Y | Y | Y | Y | Y | Y | Y |
| 644460 | Y | Y | Y | N | Y | Y | Y | Y | Y | Y | Y | Y | Y | Y | Y | Y |
| 644662 | Y | Y | Y | N | Y | Y | Y | Y | Y | Y | Y | Y | Y | Y | Y | Y |
| 644663 | Y | Y | Y | N | Y | Y | Y | Y | Y | Y | Y | Y | Y | Y | Y | Y |
| 644687 | Y | Y | Y | Y | Y | Y | Y | Y | Y | Y | Y | Y | Y | Y | Y | Y |
| 644718 | Y | Y | Y | Y | Y | Y | Y | Y | Y | Y | Y | Y | Y | Y | Y | Y |
| 644720 | Y | Y | Y | N | Y | Y | Y | Y | Y | Y | Y | Y | Y | Y | Y | Y |

Matrix for .000015
[0.00038] Gold Plated
Part Numbers

| Connectors | Headers | | | | | | | | | | | | | | | |
|------------|---------|--------|--------|--------|--------|--------|--------|--------|--------|--------|--------|--------|--------|--------|--------|--------|
| | 641113 | 641114 | 641115 | 641118 | 641119 | 641120 | 641121 | 641121 | 641121 | 641121 | 641121 | 641121 | 641121 | 641121 | 641121 | 641121 |
| 641148 | Y | Y | Y | N | Y | Y | Y | Y | Y | Y | Y | Y | Y | Y | Y | Y |
| 641149 | Y | Y | Y | N | Y | Y | Y | Y | Y | Y | Y | Y | Y | Y | Y | Y |
| 641150 | Y | Y | Y | N | Y | Y | Y | Y | Y | Y | Y | Y | Y | Y | Y | Y |
| 641151 | Y | Y | Y | N | Y | Y | Y | Y | Y | Y | Y | Y | Y | Y | Y | Y |
| 641152 | Y | Y | Y | N | Y | Y | Y | Y | Y | Y | Y | Y | Y | Y | Y | Y |
| 641153 | Y | Y | Y | Y | Y | Y | Y | Y | Y | Y | Y | Y | Y | Y | Y | Y |
| 641154 | Y | Y | Y | Y | Y | Y | Y | Y | Y | Y | Y | Y | Y | Y | Y | Y |
| 641155 | Y | Y | Y | Y | Y | Y | Y | Y | Y | Y | Y | Y | Y | Y | Y | Y |
| 641156 | Y | Y | Y | Y | Y | Y | Y | Y | Y | Y | Y | Y | Y | Y | Y | Y |
| 641157 | Y | Y | Y | Y | Y | Y | Y | Y | Y | Y | Y | Y | Y | Y | Y | Y |
| 641168 | Y | Y | Y | N | Y | Y | Y | Y | Y | Y | Y | Y | Y | Y | Y | Y |
| 641169 | Y | Y | Y | N | Y | Y | Y | Y | Y | Y | Y | Y | Y | Y | Y | Y |
| 641170 | Y | Y | Y | N | Y | Y | Y | Y | Y | Y | Y | Y | Y | Y | Y | Y |
| 641171 | Y | Y | Y | N | Y | Y | Y | Y | Y | Y | Y | Y | Y | Y | Y | Y |
| 641172 | Y | Y | Y | N | Y | Y | Y | Y | Y | Y | Y | Y | Y | Y | Y | Y |
| 641173 | Y | Y | Y | Y | Y | Y | Y | Y | Y | Y | Y | Y | Y | Y | Y | Y |
| 641174 | Y | Y | Y | Y | Y | Y | Y | Y | Y | Y | Y | Y | Y | Y | Y | Y |
| 641175 | Y | Y | Y | Y | Y | Y | Y | Y | Y | Y | Y | Y | Y | Y | Y | Y |
| 641176 | Y | Y | Y | Y | Y | Y | Y | Y | Y | Y | Y | Y | Y | Y | Y | Y |
| 641177 | Y | Y | Y | Y | Y | Y | Y | Y | Y | Y | Y | Y | Y | Y | Y | Y |
| 644284 | Y | Y | Y | N | Y | Y | Y | Y | Y | Y | Y | Y | Y | Y | Y | Y |
| 647478 | Y | Y | Y | N | Y | Y | Y | Y | Y | Y | Y | Y | Y | Y | Y | Y |
| 647479 | Y | Y | Y | N | Y | Y | Y | Y | Y | Y | Y | Y | Y | Y | Y | Y |
| 647496 | Y | Y | Y | Y | Y | Y | Y | Y | Y | Y | Y | Y | Y | Y | Y | Y |

MTA-156 IDC Connectors—Closed End

Material and Finish

Housing — UL94V-2 rated, nylon, see below for color; or UL94V-0 rated, nylon, black

Contacts — Phosphor bronze, post tin plated, .000030 [0.00076] or .000015 [.00038] post gold plated over nickel

Color Coding by Wire Size for UL94V-2 Connectors

- 26 AWG — Blue
- 24 AWG — White
- 22 AWG — Red
- 20 AWG — Yellow
- 18 AWG — Orange

All Wire Sizes in UL94V-0 — Black

Notes:

1. Only connectors with locking ramp and without polarizing tabs mate with posted connectors on page 45.
2. Refer to pages 70 thru 74 for approved wire listing.
3. For strain reliefs and dust covers, see pages 40 and 41.
4. For keying plugs and panel mount end caps, see page 42.
5. Other circuit sizes are available upon request. Minimums may apply.
6. Connector circuits can be molded closed for keying purposes. Minimums may apply.
7. Where no part numbers appear in the chart, parts can be made available upon request. Minimums may apply.
8. To determine connector overall length (Dim. A), multiply .156 x the number of circuits. Example: .156 x 10 circuits equals 1.560 inches [39.62 mm].

Closed End with Locking Ramp



without Polarizing Tabs



with Polarizing Tabs

For mateability options, see matrix on pages 34 and 35.

Mating half visuals for Closed End Connectors with Locking Ramp, see pages 45 thru 48, 50, 52, and 53, (49 and 51 Front Bend Headers Only).

Closed End without Locking Ramp



without Polarizing Tabs



with Polarizing Tabs

For mateability options, see matrix on pages 34 and 35.

Mating half visuals for Closed End Connectors without Locking Ramp, see pages 46 thru 53.

MTA-156
.156 [3.96]

MTA-156 IDC Connectors—Closed End (Continued)

Connector Ordering Information

The “Base Part Numbers” Chart at right shows the base part number and number of circuits available for the described connectors.

Prefixes and suffixes are determined by the number of circuit positions in the connector. For example, the complete part number for a 10-position closed end connector with locking ramp and without polarizing tabs for 18 AWG wire would be:

Base number **640426** plus prefix-and-suffix

4- -0

The correct ordering number is

4-640426-0

All part numbers in **bold face** are the RoHS equivalent version. Example:

| No. of Pos. | Lead Free RoHS Prefix/Suffix |
|-------------|------------------------------|
| 2 | 3-640426-2 |
| 3 | 3-640426-3 |
| 4 | 3-640426-4 |
| 5 | 3-640426-5 |
| 6 | 3-640426-6 |
| 7 | 3-640426-7 |
| 8 | 3-640426-8 |
| 9 | 3-640426-9 |
| 10 | 4-640426-0 |
| 11 | 4-640426-1 |
| 12 | 4-640426-2 |
| 13 | 4-640426-3 |
| 14 | 4-640426-4 |
| 15 | 4-640426-5 |
| 16 | 4-640426-6 |
| 17 | 4-640426-7 |
| 18 | 4-640426-8 |
| 19 | 4-640426-9 |
| 20 | 5-640426-0 |
| 21 | 5-640426-1 |
| 22 | 5-640426-2 |
| 23 | 5-640426-3 |
| 24 | 5-640426-4 |

Note: All RoHS equivalent part numbers may not be available upon catalog release. If the number you need is not available, please contact Product Engineering to expedite your request.

Base Part Numbers

| Connector Type & Wire Size | Closed End with Locking Ramp | | | | Closed End without Locking Ramp | | | |
|--------------------------------------------------------|------------------------------|-----------------------|---------------------|-----------------------|---------------------------------|--------------|---------------------|--------------|
| | Without Tabs | | With Tabs | | Without Tabs | | With Tabs | |
| | Connector Part Nos. | Connector RoHS Equiv. | Connector Part Nos. | Connector RoHS Equiv. | Connector Part Nos. | RoHS Equiv. | Part Nos. | RoHS Equiv. |
| Standard UL94V-2, Tin Plated | | | | | | | | |
| 18 AWG 0.8–0.9 mm ² | 640426 | 32–54 | 643817 | 32–54 | 640431 | 32–54 | 644461 ¹ | 32–44 |
| 20 AWG 0.5–0.6 mm ² | 640427 | 32–54 | 643818 | 32–54 | 640432 | 32–54 | 644462 ¹ | 32–44 |
| 22 AWG 0.3–0.4 mm ² | 640428 | 32–54 | 643819 | 32–54 | 640433 | 32–54 | 644463 ¹ | 32–44 |
| 24 AWG 0.2 mm ² | 640429 | 32–54 | 643820 | 32–54 | 640434 | 32–54 | 644464 ¹ | 32–44 |
| 26 AWG 0.12–0.15 mm ² | 640430 | 32–54 | 643821 | 32–54 | 640435 | 32–54 | — | — |
| Tape Mounted on Reel UL94V-2, Tin Plated | | | | | | | | |
| 18 AWG 0.8–0.9 mm ² | 640472 | 32–54 | 644878 | 32–54 | 640477 | 32–54 | — | — |
| 20 AWG 0.5–0.6 mm ² | 640473 | 32–54 | — | — | 640478 | 32–54 | — | — |
| 22 AWG 0.3–0.4 mm ² | 640474 | 32–54 | 644783 | 32–54 | 640479 | 32–54 | 644791 ¹ | 32–44 |
| 24 AWG 0.2 mm ² | 640475 | 32–54 | — | — | 640480 | 32–54 | — | — |
| 26 AWG 0.12–0.15 mm ² | 640476 | 32–54 | — | — | 640481 | 32–54 | — | — |
| Standard UL94V-2, .000030 [0.00076] Gold Plated | | | | | | | | |
| 18 AWG 0.8–0.9 mm ² | 641217 | 32–54 | 644460 ¹ | 32–42 | 641222 | 32–54 | — | — |
| 20 AWG 0.5–0.6 mm ² | 641218 | 32–54 | 644663 ¹ | 32–42 | 641223 | 32–54 | — | — |
| 22 AWG 0.3–0.4 mm ² | 641219 | 32–54 | 644662 ¹ | 32–42 | 641224 | 32–54 | 644687 ¹ | 32–44 |
| 24 AWG 0.2 mm ² | 641220 | 32–54 | — | — | 641225 | 32–54 | — | — |
| 26 AWG 0.12–0.15 mm ² | 641221 | 32–54 | — | — | 641226 | 32–54 | — | — |
| Standard UL94V-2, .000015 [0.00038] Gold Plated | | | | | | | | |
| 18 AWG 0.8–0.9 mm ² | 641148 | 32–54 | 644284 ¹ | 32–42 | 641153 | 32–54 | — | — |
| 20 AWG 0.5–0.6 mm ² | 641149 | 32–54 | — | — | 641154 | 32–54 | — | — |
| 22 AWG 0.3–0.4 mm ² | 641150 | 32–54 | 647478 ¹ | 32–42 | 641155 | 32–54 | — | — |
| 24 AWG 0.2 mm ² | 641151 | 32–54 | — | — | 641156 | 32–54 | — | — |
| 26 AWG 0.12–0.15 mm ² | 641152 | 32–54 | — | — | 641157 | 32–54 | — | — |
| Standard UL94V-0, Tin Plated (Black in color) | | | | | | | | |
| 18 AWG 0.8–0.9 mm ² | 644860 ¹ | 32–42 | — | — | 644502 ¹ | 32–42 | 644082 ¹ | 32–42 |
| 22 AWG 0.3–0.4 mm ² | — | — | — | — | 644501 ¹ | 32–42 | 644566 ¹ | 32–42 |

¹ Other circuit sizes are available upon request. Minimums may apply.

Note: Blocked circuit configurations are available upon request. Contact product engineer or product manager for details. Minimums may apply.

MTA-156 IDC Connectors—Feed-Thru

Material and Finish

Housing — UL94V-2 rated, nylon, see below for color; or UL94V-0 rated, nylon, black

Contacts — Phosphor bronze; post tin plated, .000030 [.00076] or .000015 [.00038] post gold plated over nickel

Color Coding by Wire Size for UL94V-2 Connectors

- 26 AWG — Blue
- 24 AWG — White
- 22 AWG — Red
- 20 AWG — Yellow
- 18 AWG — Orange

All Wire Sizes in UL94V-0 — Black

Notes:

1. Only connectors with locking ramp and without polarizing tabs mate with posted connectors on page 45.
2. Refer to pages 70 thru 74 for approved wire listing.
3. For strain reliefs and dust covers, see pages 40 and 41.
4. For keying plugs and panel mount end caps, see page 42.
5. Other circuit sizes are available upon request. Minimums may apply.
6. Connector circuits can be molded closed for keying purposes. Minimums may apply.
7. Where no part numbers appear in the chart, parts can be made available upon request. Minimums may apply.
8. To determine connector overall length (Dim. A), multiply .156 x the number of circuits. Example: .156 x 10 circuits equals 1.560 inches [39.62 mm].

Feed-Thru with Locking Ramp

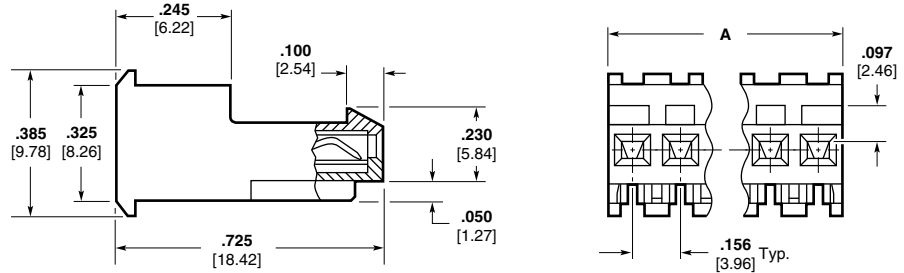

without Polarizing Tabs



with Polarizing Tabs

For mateability options, see matrix on pages 34 and 35.

Mating half visuals for Feed-Thru Connectors with Locking Ramp, see pages 45 thru 48, 50, 52, and 53, (49 and 51 Front Bend Headers Only).

Feed-Thru without Locking Ramp



without Polarizing Tabs



with Polarizing Tabs

For mateability options, see matrix on pages 34 and 35.

Mating half visuals for Feed-Thru Connectors without Locking Ramp, see pages 46 thru 53.

MTA-156 .156 [3.96]

MTA-156 IDC Connectors—Feed-Thru (Continued)

Connector Ordering Information

The “Base Part Numbers” Chart at right shows the base part number and number of circuits available for the described connectors.

Prefixes and suffixes are determined by the number of circuit positions in the connector. For example, the complete part number for a 10-position feed-thru connector with locking ramp and without polarizing tabs for 18 AWG wire would be:

Base number **640599** plus
prefix-and-suffix
4- -0

The correct ordering number is

4-640599-0

The part numbers in **bold face** are the RoHS equivalent version. Example:

| No. of Pos. | Lead Free RoHS Prefix/Suffix |
|-------------|------------------------------|
| 2 | 3-640599-2 |
| 3 | 3-640599-3 |
| 4 | 3-640599-4 |
| 5 | 3-640599-5 |
| 6 | 3-640599-6 |
| 7 | 3-640599-7 |
| 8 | 3-640599-8 |
| 9 | 3-640599-9 |
| 10 | 4-640599-0 |
| 11 | 4-640599-1 |
| 12 | 4-640599-2 |
| 13 | 4-640599-3 |
| 14 | 4-640599-4 |
| 15 | 4-640599-5 |
| 16 | 4-640599-6 |
| 17 | 4-640599-7 |
| 18 | 4-640599-8 |
| 19 | 4-640599-9 |
| 20 | 5-640599-0 |
| 21 | 5-640599-1 |
| 22 | 5-640599-2 |
| 23 | 5-640599-3 |
| 24 | 5-640599-4 |

Note: All RoHS equivalent part numbers may not be available upon catalog release. If the number you need is not available, please contact Product Engineering to expedite your request.

Base Part Numbers

| Connector Type & Wire Size | Feed-Thru with Locking Ramp | | | | Feed-Thru without Locking Ramp | | | |
|-------------------------------------------------------|-----------------------------|-----------------------|---------------------|--------------|--------------------------------|--------------|---------------------|--------------|
| | Without Tabs | | With Tabs | | Without Tabs | | With Tabs | |
| | Connector Part Nos. | Connector RoHS Equiv. | Connector Part Nos. | RoHS Equiv. | Connector Part Nos. | RoHS Equiv. | Part Nos. | RoHS Equiv. |
| Standard UL94V-2, Tin Plated | | | | | | | | |
| 18 AWG 0.8–0.9 mm ² | 640599 | 32-54 | 644465 ¹ | 32-44 | 640604 | 32-54 | 644469 ¹ | 32-44 |
| 20 AWG 0.5–0.6 mm ² | 640600 | 32-54 | 644466 ¹ | 32-44 | 640605 | 32-54 | 644470 ¹ | 32-44 |
| 22 AWG 0.3–0.4 mm ² | 640601 | 32-54 | 644467 ¹ | 32-44 | 640606 | 32-54 | 644471 ¹ | 32-44 |
| 24 AWG 0.2 mm ² | 640602 | 32-54 | 644468 ¹ | 32-44 | 640607 | 32-54 | 644472 ¹ | 32-44 |
| 26 AWG 0.12–0.15 mm ² | 640595 | 32-54 | — | — | 640608 | 32-54 | — | — |
| Tape Mounted on Reel UL94V-2, Tin Plated | | | | | | | | |
| 18 AWG 0.8–0.9 mm ² | 641302 | 32-54 | — | — | 641306 | 32-54 | — | — |
| 20 AWG 0.5–0.6 mm ² | 641303 | 32-54 | — | — | 641307 | 32-54 | — | — |
| 22 AWG 0.3–0.4 mm ² | 641304 | 32-54 | — | — | 641308 | 32-54 | — | — |
| 24 AWG 0.2 mm ² | 641305 | 32-54 | — | — | 641309 | 32-54 | — | — |
| 26 AWG 0.12–0.15 mm ² | 641301 | 32-54 | — | — | 641310 | 32-54 | — | — |
| Standard UL94V-2, .00003 [.00076] Gold Plated | | | | | | | | |
| 18 AWG 0.8–0.9 mm ² | 641227 | 32-54 | 644718 ¹ | 32-44 | 641232 | 32-54 | — | — |
| 20 AWG 0.5–0.6 mm ² | 641228 | 32-54 | — | — | 641233 | 32-54 | — | — |
| 22 AWG 0.3–0.4 mm ² | 641229 | 32-54 | 644720 ¹ | 32-44 | 641234 | 32-54 | — | — |
| 24 AWG 0.2 mm ² | 641230 | 32-54 | — | — | 641235 | 32-54 | — | — |
| 26 AWG 0.12–0.15 mm ² | 641231 | 32-54 | — | — | 641236 | 32-54 | — | — |
| Standard UL94V-2, .000015 [.00038] Gold Plated | | | | | | | | |
| 18 AWG 0.8–0.9 mm ² | 641168 | 32-54 | 647479 ¹ | 32-42 | 641173 | 32-54 | — | — |
| 20 AWG 0.5–0.6 mm ² | 641169 | 32-54 | — | — | 641174 | 32-54 | — | — |
| 22 AWG 0.3–0.4 mm ² | 641170 | 32-54 | 647496 ¹ | 32-42 | 641175 | 32-54 | — | — |
| 24 AWG 0.2 mm ² | 641171 | 32-54 | — | — | 641176 | 32-54 | — | — |
| 26 AWG 0.12–0.15 mm ² | 641172 | 32-54 | — | — | 641177 | 32-54 | — | — |
| Standard UL94V-0, Tin Plated | | | | | | | | |
| 18 AWG 0.8–0.9 mm ² | — | — | — | — | 644567 ¹ | 32-42 | 644570 ¹ | 32-42 |
| 22 AWG 0.3–0.4 mm ² | — | — | — | — | 644569 ¹ | 32-42 | 644572 ¹ | 32-42 |

¹ Other circuit sizes are available upon request. Minimums may apply.

Note: Blocked circuit configurations are available upon request. Contact product engineer or product manager for details. Minimums may apply.

MTA-156 Connector Accessories

Closed End Covers

Material (RoHS Compliant)

Strain Relief Covers — UL94V-2 rated, nylon, white

Dust Covers — UL94V-0 rated, polyester, white

Strain Relief Covers

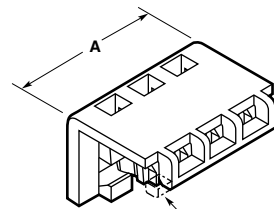

Note: This portion of front locking bar may or may not be present

Dust Covers

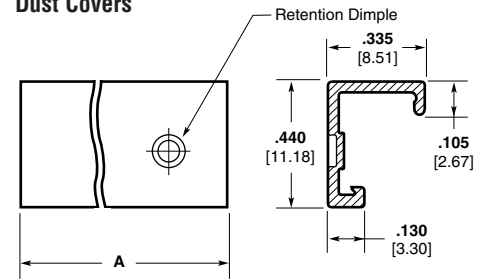

Base Part Numbers

| Closed End | | | |
|----------------------|-----------------|-----------------|-----------------|
| Strain Relief Covers | | Dust Covers | |
| Cover Part Nos. | No. of Circuits | Cover Part Nos. | No. of Circuits |
| 643067 | 2-24 | 640551 | 2-24 |

Feed-Thru Covers

Material (RoHS Compliant)

Strain Relief Covers — UL94V-2 rated, nylon, white

Dust Covers — UL94V-0 rated, polyester, white

Strain Relief Covers

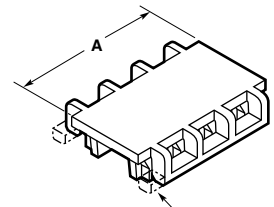

Note: This portion of front locking bar may or may not be present

Dust Covers



Base Part Numbers

| Feed-Thru | | | |
|----------------------|-----------------|-----------------|-----------------|
| Strain Relief Covers | | Dust Covers | |
| Cover Part Nos. | No. of Circuits | Cover Part Nos. | No. of Circuits |
| 643071 | 2-24 | 640643 | 2-24 |

Cover Ordering Information

The "Base Part Numbers" Chart at right shows the base part number and number of circuits available for the described cover.

Prefixes and suffixes are determined by the number of circuit positions in the cover. For example, the complete part number for a 10-position closed-end strain relief cover would be:

Base number **643067** plus prefix-and-suffix

1 — -0

The correct ordering number is

1-643067-0

Cover Length

| No. of Circuits | Dim. A | Prefix/Suffix |
|-----------------|----------------|---------------|
| 2 | .312 7.92 | -2 |
| 3 | .468 11.89 | -3 |
| 4 | .624 15.85 | -4 |
| 5 | .780 19.81 | -5 |
| 6 | .936 23.77 | -6 |
| 7 | 1.092 27.74 | -7 |
| 8 | 1.248 31.7 | -8 |
| 9 | 1.404 35.66 | -9 |

| No. of Circuits | Dim. A | Prefix/Suffix |
|-----------------|----------------|---------------|
| 10 | 1.560 39.62 | 1- -0 |
| 11 | 1.716 43.59 | 1- -1 |
| 12 | 1.872 47.55 | 1- -2 |
| 13 | 2.028 51.51 | 1- -3 |
| 14 | 2.184 55.47 | 1- -4 |
| 15 | 2.340 59.44 | 1- -5 |
| 16 | 2.496 63.4 | 1- -6 |
| 17 | 2.652 67.36 | 1- -7 |

| No. of Circuits | Dim. A | Prefix/Suffix |
|-----------------|----------------|---------------|
| 18 | 2.808 71.32 | 1- -8 |
| 19 | 2.964 75.29 | 1- -9 |
| 20 | 3.120 79.25 | 2- -0 |
| 21 | 3.276 83.21 | 2- -1 |
| 22 | 3.432 87.17 | 2- -2 |
| 23 | 3.588 91.14 | 2- -3 |
| 24 | 3.744 95.1 | 2- -4 |

MTA-156
.156 [3.96]

MTA-156 Connector Accessories (Continued)

Replacement IDC Contacts

Material and Finish

Contacts — Phosphor bronze, post tin plated; .000030 [0.00076] or .000015 [0.00038] post gold plated over nickel

Note: Tyco Electronics does not recommend terminating an MTA contact more than one time. Use replacement contacts when required for field repairs or wire changes.



| Wire Size | | Part Numbers | | |
|-----------|-----------------|--------------|----------------------------------|----------------------------------|
| AWG | mm ² | Tin Plated | .000030 [0.00076] Gold Plated | .000015 [0.00038] Gold Plated |
| 18 | 0.8–0.9 | 640631-3 | 641143-4 | 641143-3 |
| 20 | 0.5–0.6 | 640632–3 | 641144-4 | 641144-3 |
| 22 | 0.3–0.4 | 640633-3 | 641145-4 | 641145-3 |
| 24 | 0.2 | 640634-3 | 641146-4 | 641146-3 |
| 26 | 0.12–0.15 | 640635-3 | 641147-4 | 641147-3 |

Crimp Snap-in Contacts

Material and Finish

Contacts — Phosphor bronze, tin plated



| Wire Size | | Part Nos. | |
|-----------|-----------------|--------------|----------|
| AWG | mm ² | Loose Piece* | Strip** |
| 26–22 | .12–0.3 | 640557-3 | 640556-3 |
| 22–18 | 0.3–0.9 | 640559-3 | 640558-3 |

*Hand Tool No. 59837-1 (408-6528)
**AMP-O-LECTRIC Model "G" Termination Machine (Request Catalog 65828)
Note: Requires applicator. For part number, call Technical Support.

Special applications for crimp snap-in contacts are:

1. Double wire per contact
2. Coax or shielded wire
3. Mixed wire size in same connector

Note: Only one crimp snap-in contact per connector.

MTA-156 Connector Accessories (Continued)

Keying Plugs

Material (RoHS Compliant)

UL94V-2 rated, nylon, natural color

Note: Removal of contact is not necessary when using keying plug.

Loose Piece

Part No. 640629-1 (Flush)
Used with keyed headers



Part No. 640630-1 (Long Nose)
Used with staked post



On Carrier Strip

Part No. 641623-1 (Flush)
(10 per strip)



Panel Mount End Caps

Part No. 641440-1
Part No. 641533-1
(2-position only)

Material (RoHS Compliant)

UL94V-2 rated, nylon, black

Notes:

- Both left-hand and right-hand end caps are attached by a connecting tab. This tab must be broken off prior to installing on connector.
- For best results attach panel mount end caps to the MTA-156 (IDC) connectors shown on pages 36 thru 39. While not preferred, panel mount end caps can be attached to MTA-156 (IDC) posted connector on page 45.



3- thru 24-Position
641440-1
See Note 1



Two-Position Only
641533-1

| No. of Pos. | Dim. A |
|-------------|----------------|
| 3 | .736 18.69 |
| 4 | .892 22.66 |
| 6 | 1.204 30.58 |
| 9 | 1.672 42.47 |
| 12 | 2.140 54.36 |
| 15 | 2.608 66.24 |
| 24 | 4.012 101.9 |

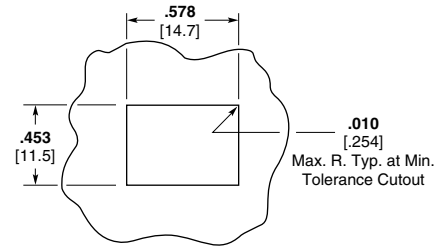

Recommended Panel Cutout
(Recommended Panel Thickness .062 [1.57] to .067 [1.70] max.)

MTA-156
.156 [3.96]

MTA-156 Posted Connector/Connector Mateability Guide

Matrix for Tin Plated Part Numbers

This matrix has been prepared to assist you, our customer, in defining the correct mating halves for the MTA-156 posted connector and connector combination. Where a "Y" is indicated the combination is a valid mating pair. Where an "N" is indicated the combination is not acceptable for mating.

| Connectors | Posted Connectors | | | | | | | | | |
|------------|-------------------|--------|--------|--------|--------|--------|--------|--------|--------|--------|
| | 641436 | 641436 | 641437 | 641438 | 641439 | 641522 | 641523 | 641524 | 641525 | 641526 |
| 640426 | Y | Y | Y | Y | Y | Y | Y | Y | Y | Y |
| 640427 | Y | Y | Y | Y | Y | Y | Y | Y | Y | Y |
| 640428 | Y | Y | Y | Y | Y | Y | Y | Y | Y | Y |
| 640429 | Y | Y | Y | Y | Y | Y | Y | Y | Y | Y |
| 640430 | Y | Y | Y | Y | Y | Y | Y | Y | Y | Y |
| 640431 | N | N | N | N | N | N | N | N | N | N |
| 640432 | N | N | N | N | N | N | N | N | N | N |
| 640433 | N | N | N | N | N | N | N | N | N | N |
| 640434 | N | N | N | N | N | N | N | N | N | N |
| 640435 | N | N | N | N | N | N | N | N | N | N |
| 640472 | Y | Y | Y | Y | Y | Y | Y | Y | Y | Y |
| 640473 | Y | Y | Y | Y | Y | Y | Y | Y | Y | Y |
| 640474 | Y | Y | Y | Y | Y | Y | Y | Y | Y | Y |
| 640475 | Y | Y | Y | Y | Y | Y | Y | Y | Y | Y |
| 640476 | Y | Y | Y | Y | Y | Y | Y | Y | Y | Y |
| 640477 | N | N | N | N | N | N | N | N | N | N |
| 640478 | N | N | N | N | N | N | N | N | N | N |
| 640479 | N | N | N | N | N | N | N | N | N | N |
| 640480 | N | N | N | N | N | N | N | N | N | N |
| 640481 | N | N | N | N | N | N | N | N | N | N |
| 640595 | Y | Y | Y | Y | Y | Y | Y | Y | Y | Y |
| 640599 | Y | Y | Y | Y | Y | Y | Y | Y | Y | Y |
| 640600 | Y | Y | Y | Y | Y | Y | Y | Y | Y | Y |
| 640601 | Y | Y | Y | Y | Y | Y | Y | Y | Y | Y |
| 640602 | Y | Y | Y | Y | Y | Y | Y | Y | Y | Y |
| 640604 | N | N | N | N | N | N | N | N | N | N |
| 640605 | N | N | N | N | N | N | N | N | N | N |
| 640606 | N | N | N | N | N | N | N | N | N | N |
| 640607 | N | N | N | N | N | N | N | N | N | N |
| 640608 | N | N | N | N | N | N | N | N | N | N |
| 641301 | Y | Y | Y | Y | Y | Y | Y | Y | Y | Y |
| 641302 | Y | Y | Y | Y | Y | Y | Y | Y | Y | Y |
| 641303 | Y | Y | Y | Y | Y | Y | Y | Y | Y | Y |
| 641304 | Y | Y | Y | Y | Y | Y | Y | Y | Y | Y |
| 641305 | Y | Y | Y | Y | Y | Y | Y | Y | Y | Y |
| 641306 | N | N | N | N | N | N | N | N | N | N |
| 641307 | N | N | N | N | N | N | N | N | N | N |
| 641308 | N | N | N | N | N | N | N | N | N | N |
| 641309 | N | N | N | N | N | N | N | N | N | N |
| 641310 | N | N | N | N | N | N | N | N | N | N |
| 643817 | N | N | N | N | N | N | N | N | N | N |
| 643818 | N | N | N | N | N | N | N | N | N | N |
| 643819 | N | N | N | N | N | N | N | N | N | N |
| 643820 | N | N | N | N | N | N | N | N | N | N |
| 643821 | N | N | N | N | N | N | N | N | N | N |
| 644082 | N | N | N | N | N | N | N | N | N | N |
| 644461 | N | N | N | N | N | N | N | N | N | N |
| 644462 | N | N | N | N | N | N | N | N | N | N |
| 644463 | N | N | N | N | N | N | N | N | N | N |
| 644464 | N | N | N | N | N | N | N | N | N | N |
| 644465 | N | N | N | N | N | N | N | N | N | N |
| 644466 | N | N | N | N | N | N | N | N | N | N |
| 644467 | N | N | N | N | N | N | N | N | N | N |
| 644468 | N | N | N | N | N | N | N | N | N | N |
| 644469 | N | N | N | N | N | N | N | N | N | N |
| 644470 | N | N | N | N | N | N | N | N | N | N |
| 644471 | N | N | N | N | N | N | N | N | N | N |
| 644472 | N | N | N | N | N | N | N | N | N | N |
| 644501 | N | N | N | N | N | N | N | N | N | N |
| 644502 | N | N | N | N | N | N | N | N | N | N |
| 644566 | N | N | N | N | N | N | N | N | N | N |
| 644567 | N | N | N | N | N | N | N | N | N | N |
| 644569 | N | N | N | N | N | N | N | N | N | N |
| 644570 | N | N | N | N | N | N | N | N | N | N |
| 644572 | N | N | N | N | N | N | N | N | N | N |
| 644783 | N | N | N | N | N | N | N | N | N | N |
| 644791 | N | N | N | N | N | N | N | N | N | N |
| 644860 | Y | Y | Y | Y | Y | Y | Y | Y | Y | Y |
| 644878 | N | N | N | N | N | N | N | N | N | N |

MTA-156 Posted Connector/Connector Mateability Guide (Continued)

This matrix has been prepared to assist you, our customer, in defining the correct mating halves for the MTA-156 posted connector and connector combination. Where a "Y" is indicated the combination is a valid mating pair. Where an "N" is indicated the combination is not acceptable for mating.

**Matrix for .000030
[0.00076] Gold Plated
Part Numbers**

Posted Connectors

| | 644807 | 644809 | 644812 | 644814 |
|--------|--------|--------|--------|--------|
| 641217 | Y | Y | Y | Y |
| 641218 | Y | Y | Y | Y |
| 641219 | Y | Y | Y | Y |
| 641220 | Y | Y | Y | Y |
| 641221 | Y | Y | Y | Y |
| 641222 | N | N | N | N |
| 641223 | N | N | N | N |
| 641224 | N | N | N | N |
| 641225 | N | N | N | N |
| 641226 | N | N | N | N |
| 641227 | Y | Y | Y | Y |
| 641228 | Y | Y | Y | Y |
| 641229 | Y | Y | Y | Y |
| 641230 | Y | Y | Y | Y |
| 641231 | Y | Y | Y | Y |
| 641232 | N | N | N | N |
| 641233 | N | N | N | N |
| 641234 | N | N | N | N |
| 641235 | N | N | N | N |
| 641236 | N | N | N | N |
| 644460 | N | N | N | N |
| 644662 | N | N | N | N |
| 644663 | N | N | N | N |
| 644687 | N | N | N | N |
| 644718 | N | N | N | N |
| 644720 | N | N | N | N |

Connectors

**Matrix for .000015
[0.00038] Gold Plated
Part Numbers**

Posted Connectors

| | 643895 | 647476 | 647481 | 647497 |
|--------|--------|--------|--------|--------|
| 641148 | Y | Y | Y | Y |
| 641149 | Y | Y | Y | Y |
| 641150 | Y | Y | Y | Y |
| 641151 | Y | Y | Y | Y |
| 641152 | Y | Y | Y | Y |
| 641153 | N | N | N | N |
| 641154 | N | N | N | N |
| 641155 | N | N | N | N |
| 641156 | N | N | N | N |
| 641157 | N | N | N | N |
| 641168 | Y | Y | Y | Y |
| 641169 | Y | Y | Y | Y |
| 641170 | Y | Y | Y | Y |
| 641171 | Y | Y | Y | Y |
| 641172 | Y | Y | Y | Y |
| 641173 | N | N | N | N |
| 641174 | N | N | N | N |
| 641175 | N | N | N | N |
| 641176 | N | N | N | N |
| 641177 | N | N | N | N |
| 644284 | N | N | N | N |
| 647478 | N | N | N | N |
| 647479 | N | N | N | N |
| 647496 | N | N | N | N |

Connectors

MTA-156
.156 [3.96]

MTA-156 IDC Posted Connectors (Wire-to-Wire)—Closed End, Feed-Thru

Material and Finish

Housing — UL 94V-2 rated, nylon, see chart for color

Contacts — Copper alloy, post tin or .000030 [.00076] gold plated over nickel

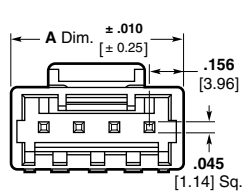

Closed End

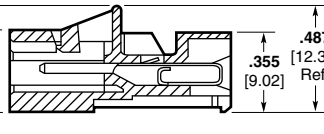
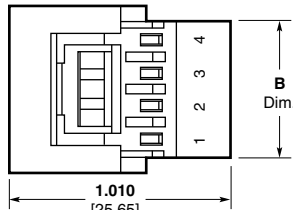

Feed-Thru

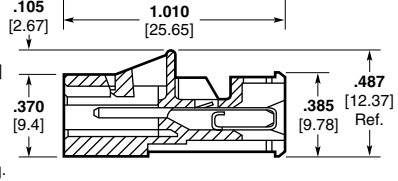
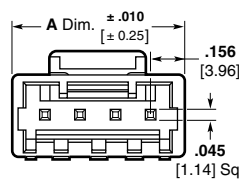
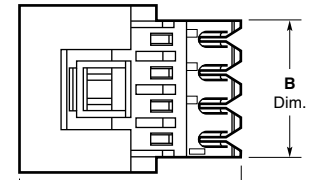

Notes:

1. Mating half visuals - pages 36 thru 39.
2. Strain relief & dust covers - pages 40 & 41.
3. Approved wire listing - page 70.

Connector Ordering Information

The "Base Part Numbers" Chart at right shows the base part number and number of circuits available for the described connectors.

Prefixes and suffixes are determined by the number of circuit positions in the connector. For example, the complete part number for a 12-position closed end connector for 18 AWG wire would be:

Base number **641435** plus prefix-and-suffix **4- -2**

The correct ordering number is **4-641435-2**

See page 15 for an explanation of RoHS lead free equivalents.

Note: All RoHS equivalent part numbers may not be available upon catalog release. If the number you need is not available, please contact Product Engineering to expedite your request.

Color Coding by Wire Size for UL 94V-2 Connectors

- 18 AWG — Orange
- 20 AWG — Yellow
- 22 AWG — Red
- 24 AWG — White
- 26 AWG — Blue

Performance Data

Voltage Rating — 600 VAC

Current Rating — 7 amp max.

Low-Level Resistance — 7 mΩ max. initial

Dielectric Withstanding Voltage — 1500 VAC/1 min.

Insulation Resistance — 5000 MΩ min. initial

Operating Temperature — -55° C to +105° C

Base Part Numbers

| Connector Type & Wire Size | Closed End Connector ¹ | | Feed-Thru Connector ¹ | |
|---------------------------------------------------------|-----------------------------------|--------------------------------|----------------------------------|--------------------------------|
| | Part Nos. | RoHS Equiv. | Part Nos. | RoHS Equiv. |
| Standard UL 94V-2, Tin Plated | | | | |
| 18 AWG 0.8-0.9 mm ² | 641435 | 32, 33, 34, 36, 39, 42, 45, 54 | 641522 | 32, 33, 34, 36, 39, 42, 45, 54 |
| 20 AWG 0.5-0.6 mm ² | 641436 | 32, 33, 34, 36, 39, 42, 45, 54 | 641523 | 32, 33, 34, 36, 39, 42, 45, 54 |
| 22 AWG 0.3-0.4 mm ² | 641437 | 32, 33, 34, 36, 39, 42, 45, 54 | 641524 | 32, 33, 34, 36, 39, 42, 45, 54 |
| 24 AWG 0.2 mm ² | 641438 | 32, 33, 34, 36, 39, 42, 45, 54 | 641525 | 32, 33, 34, 36, 39, 42, 45, 54 |
| 26 AWG 0.12-0.15 mm ² | 641439 | 32, 33, 34, 36, 39, 42, 45, 54 | 641526 | 32, 33, 34, 36, 39, 42, 45, 54 |
| Standard UL 94V-2, .000030 [0.00076] Gold Plated | | | | |
| 18 AWG 0.8-0.9 mm ² | 644807 | 32, 33, 34, 36, 39, 42, 45, 54 | 644812 | 32, 33, 34, 36, 39, 42, 45, 54 |
| 20 AWG 0.5-0.6 mm ² | — ² | — | — ² | — |
| 22 AWG 0.3-0.4 mm ² | 644809 | 32, 33, 34, 36, 39, 42, 45, 54 | 644814 | 32, 33, 34, 36, 39, 42, 45, 54 |
| 24 AWG 0.2 mm ² | — ² | — | — ² | — |
| 26 AWG 0.12-0.15 mm ² | — ² | — | — ² | — |
| Standard UL 94V-2, .000015 [0.00038] Gold Plated | | | | |
| 18 AWG 0.8-0.9 mm ² | 647476 | 32, 33, 34, 36, 39, 42, 45, 54 | 647481 | 32, 33, 34, 36, 39, 42, 45, 54 |
| 22 AWG 0.3-0.4 mm ² | 643995 | 32, 33, 34, 36, 39, 42, 45, 54 | 647497 | 32, 33, 34, 36, 39, 42, 45, 54 |

¹ MTA-156 Posted Connectors (Closed End and Feed-Thru) will **Only mate** with MTA-156 connectors with locking ramp and without polarizing tabs. They **will NOT mate** with MTA-156 Quad Connectors.

² Parts can be made available upon request. Minimums may apply.

| No. of Circuits | Dim. | | Suffix | No. of Circuits | Dim. | | Prefix/Suffix |
|-----------------|-------|-------|--------|-----------------|-------|-------|---------------|
| | A | B | | | A | B | |
| 2 | .468 | .316 | -2 | 9 | 1.560 | 1.408 | -9 |
| | 11.89 | 8.03 | | | 39.62 | 35.76 | |
| 3 | .624 | .472 | -3 | 12 | 2.028 | 1.876 | 1- -2 |
| | 15.85 | 11.99 | | | 51.51 | 47.65 | |
| 4 | .780 | .628 | -4 | 15 | 2.496 | 2.344 | 1- -5 |
| | 19.81 | 15.95 | | | 63.40 | 59.54 | |
| 6 | 1.092 | .940 | -6 | 24 | 3.900 | 3.748 | 2- -4 |
| | 27.74 | 23.88 | | | 99.06 | 95.20 | |

Technical Documents

Product Specification
108-1065 MTA-156 Posted Connector

Application Specification
114-1020 MTA-156 Connectors, Posted Connectors and Card Edge Connectors

Replacement IDC Contacts

Material and Finish

Contacts — Copper alloy, post tin plated over nickel

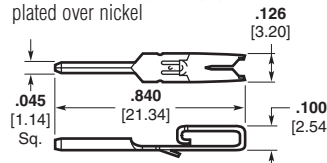

| AWG | Wire Size | | Part Numbers |
|-----|-----------------|--|--------------|
| | mm ² | | |
| 18 | 0.8-0.9 | | 3-641425-1 |
| 20 | 0.5-0.6 | | 3-641426-1 |
| 22 | 0.3-0.4 | | 3-641427-1 |
| 24 | 0.2 | | 3-641428-1 |
| 26 | 0.12-0.15 | | 3-641429-1 |

MTA-156 Flat Headers—Straight

Material and Finish

Housing—UL94V-0 rated, polyester, white

Posts—Copper alloy, tin plated, .000030 [0.00076] or .000015 [0.00038] gold over nickel

Notes:

1. Post(s) can be omitted for keying purposes. Specify the desired post(s) to be omitted using the figure to identify Post No. 1.
2. Gold headers are duplex plated, gold on mating end of post and tin on the solder tail.
3. .125 [3.18] solder tail lengths are for .062 [1.57] thick printed circuit boards and .175 [4.45] solder tail lengths are for .093-.125 [2.36-3.18] thick printed circuit boards.
4. To determine header overall length (Dim. A), multiply .156 x the number of posts. Example: .156 x 10 posts equals 1.560 inches [39.62 mm].

For mateability options, see matrix on pages 34, 35, 54 and 58.

For mating half visuals, see pages 36 thru 39, 55, 60 and 62.



Recommended Mounting Hole Pattern for .062 [1.57] Thk. PC Board

| PC Board Hole Diameters | |
|-------------------------|-----------------------|
| Square Post | Round Post |
| .080/.070 [2.03/1.78] | .070/.060 [1.78/1.52] |

Header Ordering Information

The "Base Part Numbers" Chart at right shows the base part number and number of posts available for the described headers.

Prefixes and suffixes are determined by the number of post positions in the header. For example, the complete part number for a 10-position header with square posts and a .125 [3.18] solder tail length would be:

Base number **640383** plus prefix-and-suffix **4- -0**

The correct ordering number is **4-640383-0**

The part numbers in **bold face** are the RoHS equivalent version. Example:

| No. of Pos. | Lead Free RoHS Prefix/Suffix |
|-------------|------------------------------|
| 2 | 3-640383-2 |
| | thru |
| 24 | 5-640383-4 |

See page 15 for an explanation of RoHS lead free equivalents.

Note: All RoHS equivalent part numbers may not be available upon catalog release. If the number you need is not available, please contact Product Engineering to expedite your request.

Note: Consult Product Drawing for details on placing headers onto PC boards.

Base Part Numbers

| Square Posts | | | | Round Posts | | | |
|--------------------------------------------------------|-------------|-------------------------|-------------|-------------------------|-------------|-------------------------|-------------|
| .125 [3.18] Solder tail | | .175 [4.45] Solder tail | | .125 [3.18] Solder tail | | .175 [4.45] Solder tail | |
| Header Part Nos. | RoHS Equiv. | Header Part Nos. | RoHS Equiv. | Header Part Nos. | RoHS Equiv. | Header Part Nos. | RoHS Equiv. |
| Standard UL94V-0, Tin Plated | | | | | | | |
| 640383 | 2-24 | 644749 | 2-24 | 640384 | 2-24 | 644750 | 2-24 |
| Standard UL94V-0, .000030 [0.00076] Gold Plated | | | | | | | |
| 641202 | 32-54 | 644756 | 32-54 | 641203 | 32-54 | 644757 | 32-54 |
| Standard UL94V-0, .000015 [0.00038] Gold Plated | | | | | | | |
| 641113 | 32-54 | 644763 | 32-54 | 641114 | 32-54 | 644764 | 32-54 |

Note:

Select load headers (omitted pin headers) are available upon request. Please contact product engineer or product manager for details.

MTA-156
.156 [3.96]

MTA-156 Flat Headers—Right-Angle

Material and Finish

Housing—UL94V-0 rated, polyester, white

Posts—Copper alloy, tin plated, .000030 [0.00076] or .000015 [0.00038] gold over nickel

Notes:

1. Post(s) can be omitted for keying purposes. Specify the desired post(s) to be omitted using the figure to identify Post No. 1.
2. Gold headers are duplex plated, gold on mating end of post and tin on the solder tail.
3. .125 [3.18] solder tail lengths are for .062 [1.57] thick printed circuit boards and .175 [4.45] solder tail lengths are for .093-.125 [2.36-3.18] thick printed circuit boards.
4. To determine header overall length (Dim. A), multiply .156 x the number of posts. Example: .156 x 10 posts equals 1.560 inches [39.62 mm].

For mateability options, see matrix on pages 34, 35, 54 and 58.

For mating half visuals, see pages 36 thru 39, 55, 60 and 62.

Header Ordering Information

The "Base Part Numbers" Chart at right shows the base part number and number of posts available for the described headers.

Prefixes and suffixes are determined by the number of post positions in the header. For example, the complete part number for a 10-position header with square posts and a .125 [3.18] solder tail length would be:

Base number **641204** plus prefix-and-suffix **4- -0**

The correct ordering number is **4-641204-0**

The part numbers in **bold face** are the RoHS equivalent version. Example:

| No. of Pos. | Lead Free RoHS Prefix/Suffix |
|-------------|------------------------------|
| 2 | 3-641204-2 |
| | thru |
| 24 | 5-641204-4 |

See page 15 for an explanation of RoHS lead free equivalents.

Note: All RoHS equivalent part numbers may not be available upon catalog release. If the number you need is not available, please contact Product Engineering to expedite your request.



Recommended Mounting Hole Pattern for .062 [1.57] Thk. PC Board

X = .140 [3.56] Min., .430 [10.92] Max. when mated with MTA Connector.
 X = .140 [3.56] Min. when mated with SL-156 Wire-to-Board Connector.

Note: Consult Product Drawing for details on placing headers onto PC boards.



Recommended Mounting Hole Pattern for .063 [1.60] Thk. PC Board for Retentive Leg Header
 Y = .140 [3.56] Min., .430 [10.92] Max. when mated with MTA Connector.

Base Part Numbers

| Retentive Leg | | Square Posts | | Retentive Leg | |
|--------------------------------------------------------|-------------|-------------------------|-------------|-------------------------|-------------|
| | | .125 [3.18] Solder tail | | .175 [4.45] Solder tail | |
| Header Part Nos. | RoHS Equiv. | Header Part Nos. | RoHS Equiv. | Header Part Nos. | RoHS Equiv. |
| Standard UL94V-0, Tin Plated | | | | | |
| 647646 | 2-12 | 640385 | 2-24 | 644751 | 2-24 |
| Standard UL94V-0, .000030 [0.00076] Gold Plated | | | | | |
| — | — | 641204 | 32-54 | 644758 | 32-54 |
| Standard UL94V-0, .000015 [0.00038] Gold Plated | | | | | |
| — | — | 641115 | 32-54 | 644765 | 32-54 |

Note: Select load headers (omitted pin headers) are available upon request. Please contact product engineer or product manager for details.

MTA-156 Friction Lock Headers—Straight

Material and Finish

Housing — UL94V-0 rated, polyester, white

Posts — Copper alloy, tin plated, .000030 [0.00076] or .000015 [0.00038] gold over nickel

Notes:

1. Post(s) can be omitted for keying purposes. Specify the desired post(s) to be omitted using the figure to identify Post No. 1.
2. Gold headers are duplex plated, gold on mating end of post and tin on the solder tail.
3. .125 [3.18] solder tail lengths are for .062 [1.57] thick printed circuit boards and .175 [4.45] solder tail lengths are for .093-.125 [2.36-3.18] thick printed circuit boards.
4. To determine header overall length (Dim. A), multiply .156 x the number of posts. Example: .156 x 10 posts equals 1.560 inches [39.62 mm].

For mateability options, see matrix on pages 34, 35, 54 and 58.

For mating half visuals, use connectors with a locking ramp for polarization/retention purposes, see pages 36 thru 39, 55, 60 and 62.

For polarizing purposes only use connectors without a locking ramp. See pages 36 thru 39, 55, 60 and 62.

Header Ordering Information

The “Base Part Numbers” Chart at right shows the base part number and number of posts available for the described headers.

Prefixes and suffixes are determined by the number of post positions in the header. For example, the complete part number for a 10-position header with square posts and a .125 [3.18] solder tail length would be: Base number **641208** plus prefix-and-suffix **4- -0**

The correct ordering number is **4-641208-0**

The part numbers in **bold face** are the RoHS equivalent version. Example:

| No. of Pos. | Standard Prefix/Suffix | Lead Free RoHS Prefix/Suffix |
|-------------|------------------------|------------------------------|
| 2 | 641208-2 | 3-641208-2 |
| | thru | |
| 24 | 2-641208-4 | 5-641208-4 |

See page 15 for an explanation of RoHS lead free equivalents.



Y = .068 [1.73] Max. 2-8 position tin plated and 2-24 position gold plated headers.

Y = .073 [1.85] 9-24 position tin plated headers.



Recommended Mounting Hole Pattern for .062 [1.57] Thk. PC Board

| PC Board Hole Diameters | |
|-------------------------|-----------------------|
| Square Post | Round Post |
| .080/.070 [2.03/1.78] | .070/.060 [1.78/1.52] |



Note: Consult Product Drawing for details on placing headers onto PC boards.

Base Part Numbers

| Square Posts | | | | Round Posts | | | | | |
|--------------------------------------------------------|-------------|-------------------------|-------------|-------------------------|-------------|-------------------------|-------------|-------------------------|-------------|
| Retentive Leg | | .125 [3.18] Solder tail | | .175 [4.45] Solder tail | | .125 [3.18] Solder tail | | .175 [4.45] Solder tail | |
| Header Part Nos. | RoHS Equiv. | Header Part Nos. | RoHS Equiv. | Header Part Nos. | RoHS Equiv. | Header Part Nos. | RoHS Equiv. | Header Part Nos. | RoHS Equiv. |
| Standard UL94V-0, Tin Plated | | | | | | | | | |
| 1744017 | 2-12 | 640445 | 2-24 | 644752 | 2-24 | 640388 | 2-24 | 644753 | 2-24 |
| Standard UL94V-0, .000030 [0.00076] Gold Plated | | | | | | | | | |
| — | — | 641208 | 32-54 | 644759 | 32-54 | 641209 | 32-54 | 644760 | 32-54 |
| Standard UL94V-0, .000015 [0.00038] Gold Plated | | | | | | | | | |
| — | — | 641119 | 32-54 | 644766 | 32-54 | 641120 | 32-54 | 644767 | 32-54 |

Note: All RoHS equivalent part numbers may not be available upon catalog release. If the number you need is not available, please contact Product Engineering to expedite your request.

Note:

Select load headers (omitted pin headers) and tube loaded product are available upon request. Please contact product engineer or product manager for details.

MTA-156
.156 [3.96]

MTA-156 Friction Lock Headers—Right-Angle

Material and Finish

Housing — UL94V-0 rated, polyester, white

Posts — Copper alloy, tin plated, .000030 [0.00076] or .000015 [0.00038] gold over nickel

Notes:

1. Post(s) can be omitted for keying purposes. Specify the desired post(s) to be omitted using the figure to identify Post No. 1.
2. Gold headers are duplex plated, gold on mating end of post and tin on the solder tail.
3. .125 [3.18] solder tail lengths are for .062 [1.57] thick printed circuit boards and .175 [4.45] solder tail lengths are for .093-.125 [2.36-3.18] thick printed circuit boards.
4. To determine header overall length (Dim. A), multiply .156 x the number of posts. Example: .156 x 10 posts equals 1.560 inches [39.62 mm].

For mateability options, see matrix on pages 34, 35, 54 and 58.

When using Front Bend Headers—for mating half visuals use connectors with a locking ramp for polarization/retention purposes. When using Rear Bend Headers—for mating half visuals use connectors without a locking ramp. For polarization purposes only see pages 36 thru 39, 55, 60 and 62.



Recommended Mounting Hole Pattern for .062 [1.57] Thk. PC Board

Y = .068 [1.73] Max. 2-8 position tin plated and 2-24 position gold plated headers.

Y = .073 [1.85] 9-24 position tin plated headers.



Front Bend
 X = .325 [8.26] Min., .400 [10.16] Max., when mated with MTA Connector.
 X = .325 [8.26] Min., .345 [8.76] Max., when mated with SL-156 Connector.

Rear Bend
 X = .500 [12.7] Min., .650 [16.51] Max., when mated with MTA Connector.
 X = .500 [12.7] Min., when mated with SL-156 Connector.

Header Ordering Information

The “Base Part Numbers” Chart at right shows the base part number and number of posts available for the described headers.

Prefixes and suffixes are determined by the number of post positions in the header. For example, the complete part number for a 10-position header with square posts, front bend, and a .125 [3.18] solder tail length would be:

Base number **641210** plus prefix-and-suffix **4- -0**

The correct ordering number is **4-641210-0**

The part numbers in **bold face** are the RoHS equivalent version. Example:

| No. of Pos. | Standard Prefix/Suffix | Lead Free RoHS Prefix/Suffix |
|-------------|------------------------|------------------------------|
| 2 | 641210-2 | 3-641210-2 |
| | thru | |
| 24 | 2-641210-4 | 5-641210-4 |

See page 15 for an explanation of RoHS lead free equivalents.

Note: Consult Product Drawing for details on placing headers onto PC boards.

Base Part Numbers

| Square Posts | | | | | | | |
|--------------------------------------------------------|-------------|-------------------------|-------------|-------------------------|-------------|-------------------------|-------------|
| Front Bend | | | | Rear Bend | | | |
| .125 [3.18] Solder tail | | .175 [4.45] Solder tail | | .125 [3.18] Solder tail | | .175 [4.45] Solder tail | |
| Header Part Nos. | RoHS Equiv. | Header Part Nos. | RoHS Equiv. | Header Part Nos. | RoHS Equiv. | Header Part Nos. | RoHS Equiv. |
| Standard UL94V-0, Tin Plated | | | | | | | |
| 640389 | 2-24 | 644754 | 2-24 | 640387 | 2-24 | 644755 | 2-24 |
| Standard UL94V-0, .000030 [0.00076] Gold Plated | | | | | | | |
| 641210 | 32-54 | 644761 | 32-54 | 641207 | 32-54 | 644762 | 32-54 |
| Standard UL94V-0, .000015 [0.00038] Gold Plated | | | | | | | |
| 641121 | 32-54 | 644768 | 32-54 | 641118 | 32-54 | 644769 | 32-54 |

Note: All RoHS equivalent part numbers may not be available upon catalog release. If the number you need is not available, please contact Product Engineering to expedite your request.

Note: Select lead headers (omitted pin headers) are available upon request. Please contact product engineer or product manager for details.

MTA-156 Polarized Lock Headers—Straight

Material and Finish

Housing — UL94V-0 rated, polyester, white

Posts — Copper alloy, tin plated or .000030 [0.00076] gold over nickel

Notes:

1. Post(s) can be omitted for keying purposes. Specify the desired post(s) to be omitted using the figure to identify Post No. 1.
2. Peg holes are not required in PC Boards when headers without pegs are used.
3. One peg only on a 2 position header, other position sizes have two pegs.
4. Headers with .00015 [0.00038] gold plated post are available upon request. Minimums may apply.
5. To determine header overall length (Dim. A), multiply .156 x the number of posts. Example: .156 x 10 posts equals 1.560 inches [39.62 mm].

For mateability options, see matrix on pages 34, 35, 54 and 58.

For mating half visuals, use connectors with a locking ramp for polarization/retention purposes, see pages 36 thru 39, 55, 60 and 62.

For polarizing purposes only use connectors without a locking ramp. See pages 36 thru 39, 60 and 62.



| PC Board Hole Diameters | |
|--------------------------|--------------------------|
| Square Post | Round Post |
| .069/.065 [1.75/1.65] | .054/.050 [1.37/1.27] |

Recommended Mounting Hole Pattern for .062 [1.57] Thk. PC Board

Note: Consult Product Drawing for details on placing headers onto PC boards.

Header Ordering Information

The "Base Part Numbers" Chart at right shows the base part number and number of posts available for the described headers.

Prefixes and suffixes are determined by the number of post positions in the header. For example, the complete part number for a 10-position header with square posts with pegs would be:

Base number **644615** plus prefix-and-suffix **4- -0**

The correct ordering number is **4-644615-0**

The part numbers in **bold face** are the RoHS equivalent version. Example:

| No. of Pos. | Lead Free RoHS Prefix/Suffix |
|-------------|------------------------------|
| 2 | 3-644615-2 |
| | thru |
| 18 | 4-644615-8 |

See page 15 for an explanation of RoHS lead free equivalents.

Base Part Numbers

| Square Posts | | | | Round Posts | | | |
|--------------------------------------------------------|--------------|------------------|--------------|------------------|--------------|------------------|--------------|
| Without Pegs | | With Pegs | | Without Pegs | | With Pegs | |
| Header Part Nos. | RoHS Equiv. | Header Part Nos. | RoHS Equiv. | Header Part Nos. | RoHS Equiv. | Header Part Nos. | RoHS Equiv. |
| Standard UL94V-0, Tin Plated | | | | | | | |
| 644611 | 32-48 | 644615 | 32-48 | 644612 | 32-48 | 644616 | 32-48 |
| Standard UL94V-0, .000030 [0.00076] Gold Plated | | | | | | | |
| 644627 | 32-48 | 644631 | 32-48 | 644628 | 32-48 | 644632 | 32-48 |

Note: All RoHS equivalent part numbers may not be available upon catalog release. If the number you need is not available, please contact Product Engineering to expedite your request.

Note: Select load headers (omitted pin headers) are available upon request. Please contact product engineer or product manager for details.

MTA-156
.156 [3.96]

MTA-156 Polarized Lock Headers—Right-Angle

Material and Finish

Housing—UL94V-0 rated, polyester, white

Posts—Copper alloy, tin plated or .000030 [0.00076] gold over nickel

Notes:

1. Post(s) can be omitted for keying purposes. Specify the desired post(s) to be omitted using the figure to identify Post No. 1.
2. Peg holes are not required in PC Boards when headers without pegs are used.
3. One peg only on a 2 position header, other position sizes have two pegs.
4. Headers with .00015 [0.00038] gold plated post are available upon request. Minimums may apply.
5. To determine header overall length (Dim. A), multiply .156 x the number of posts. Example: .156 x 10 posts equals 1.560 inches [39.62 mm].

For mateability options, see matrix on pages 34, 35, 54 and 58.

For mating half visuals, use only connectors with a locking ramp for polarization/retention purposes, see pages 36 thru 39, 55, 60 and 62.

For polarizing purposes only use connectors without a locking ramp. See pages 36 thru 39, 60 and 62.



Recommended Mounting Hole Pattern for .062 [1.57] Thk. PC Board

Note: Consult Product Drawing for details on placing headers onto PC boards.

Header Ordering Information

The "Base Part Numbers" Chart at right shows the base part number and number of posts available for the described headers.

Prefixes and suffixes are determined by the number of post positions in the header. For example, the complete part number for a 10-position header with front bend and with pegs would be:

Base number **644617** plus prefix-and-suffix **4- -0**

The correct ordering number is **4-644617-0**

The part numbers in **bold face** are the RoHS equivalent version. Example:

| No. of Pos. | Lead Free RoHS Prefix/Suffix |
|-------------|------------------------------|
| 2 | 3-644617-2 |
| | thru |
| 18 | 4-644617-8 |

See page 15 for an explanation of RoHS lead free equivalents.

Base Part Numbers

| Square Posts | | | | | |
|--------------------------------------------------------|--------------|------------------|--------------|------------------|--------------|
| Front Bend | | | | Rear Bend | |
| Without Pegs | | With Pegs | | Without Pegs | |
| Header Part Nos. | RoHS Equiv. | Header Part Nos. | RoHS Equiv. | Header Part Nos. | RoHS Equiv. |
| Standard UL94V-0, Tin Plated | | | | | |
| 644613 | 32-48 | 644617 | 32-48 | 644614 | 32-48 |
| Standard UL94V-0, .000030 [0.00076] Gold Plated | | | | | |
| 644629 | 32-48 | 644633 | 32-48 | 644630 | 32-48 |

Note: All RoHS equivalent part numbers may not be available upon catalog release. If the number you need is not available, please contact Product Engineering to expedite your request.

Note: Select load headers (omitted pin headers) are available upon request. Please contact product engineer or product manager for details.

MTA-156 Friction Lock High Temperature Headers—Straight

Material and Finish

Housing — UL94V-0 rated, nylon, black

Posts — Copper alloy, tin plated, .000015 [0.00038] gold over nickel

Temperature — Maximum Temperature Rating: 280°C

Notes:

1. Post(s) can be omitted for keying purposes. Specify the desired post(s) to be omitted using the figure to identify Post No. 1.
2. Gold headers are duplex plated, gold on mating end of post and tin-lead on the solder tail.
3. Headers with straight and right-angle square posts are available upon request. Minimums may apply.
4. To determine header overall length (Dim. A), multiply .156 x the number of posts. Example: .156 x 10 posts equals 1.560 inches [39.62 mm].

For mateability options, see matrix on pages 34, 35, 54 and 58.

For mating half visuals, use connectors with a locking ramp for polarization/retention purposes, see pages 36 thru 39, 55, 60 and 62.

For polarizing purposes only use connectors without a locking ramp. See pages 36 thru 39, 60 and 62.

Header Ordering Information

The “Base Part Numbers” Chart at right shows the base part number and number of posts available for the described headers.

Prefixes and suffixes are determined by the number of post positions in the header. For example, the complete part number for a 10-position header with round tin plated posts:

Base number **647648** plus prefix-and-suffix **4- -0**

The correct ordering number is **4-647648-0**

The part numbers in **bold face** are the RoHS equivalent version. Example:

| No. of Pos. | Lead Free RoHS Prefix/Suffix |
|-------------|------------------------------|
| 2 | 3-647648-2 |
| 12 | 4-647648-2 |

See page 15 for an explanation of RoHS lead free equivalents.

Note: All RoHS equivalent part numbers may not be available upon catalog release. If the number you need is not available, please contact Product Engineering to expedite your request.

For use with Infrared Reflow Process



Recommended Mounting Hole Pattern for .062 [1.57] Thick PC Board

Note: Consult Product Drawing for details on placing headers onto PC boards.

Base Part Numbers

| Round Post | | |
|--------------------------------------------------------|--------|--------------|
| Header Part Nos. | | RoHS Equiv. |
| Standard UL94V-0, Tin Plated | 647648 | 32-42 |
| Standard UL94V-0, .000015 [0.00038] Gold Plated | 647649 | 32-42 |

Note:

Select load headers (omitted pin headers) are available upon request. Please contact product engineer or product manager for details.

MTA-156
.156 [3.96]

MTA-156 Shrouded Headers—Straight and Right-Angle

Material and Finish

Housing—UL94V-0 rated, polyester, black

Posts—Copper alloy, tin plated; or .000030 [0.00076] or .000015 [0.00038] gold over nickel

Notes:

1. Post(s) can be omitted for keying purposes. Specify the desired post(s) to be omitted using the figure to identify Post No. 1.
2. Gold headers are duplex plated, gold on mating end of post and tin on the solder tail.
3. Peg holes are not required in PC boards when headers without pegs are used.
4. One peg only on a 2 position header, other position sizes have two pegs.
5. Right-angle front and rear bend headers with retention pegs can be made available upon request. Minimums may apply.

For mateability options, see matrix on pages 34, 35, 54 and 58.

For mating half visuals, see pages 36 thru 39 and 55.

Header Ordering Information

The “Base Part Numbers” Chart at right shows the base part number and number of posts available for the described headers.

Prefixes and suffixes are determined by the number of post positions in the header. For example, the complete part number for a 10-position header with straight, square posts and with pegs would be: Base number **647127** plus prefix-and-suffix **4--0**

The correct ordering number is **4-647127-0**

| No. of Pos. | Dim. A | RoHS Prefix/Suffix |
|-------------|----------------|--------------------|
| 2 | .406 10.31 | 2--2 |
| 3 | .562 14.27 | 2--3 |
| 4 | .718 18.24 | 2--4 |
| 5 | .874 22.20 | 2--5 |
| 6 | 1.030 26.16 | 2--6 |
| 7 | 1.186 30.12 | 2--7 |
| 8 | 1.342 34.09 | 2--8 |
| 9 | 1.498 38.05 | 2--9 |
| 10 | 1.654 42.01 | 3--0 |
| 11 | 1.810 45.97 | 3--1 |
| 12 | 1.966 49.94 | 3--2 |

Note: All RoHS equivalent part numbers may not be available upon catalog release. If the number you need is not available, please contact Product Engineering to expedite your request.

Straight Post (.045 [1.14] Square or Round)



Right-Angle (.045 [1.14] Square)

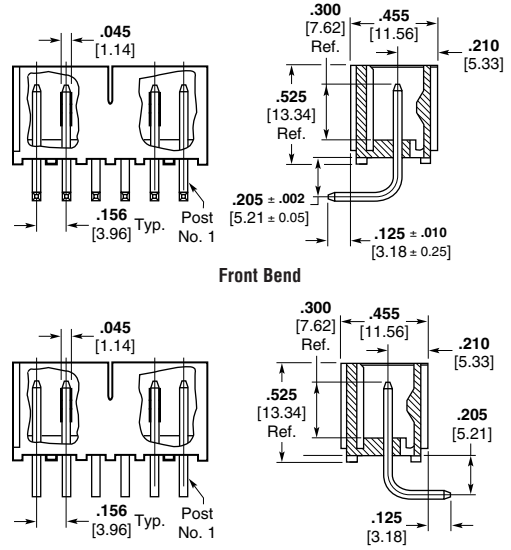

PC Board Hole Diameters

| Square Post | Round Post |
|--------------------------|--------------------------|
| .069/.065 [1.75/1.65] | .054/.050 [1.37/1.27] |

Note: Consult Product Drawing for details on placing headers onto PC boards.



Recommended Mounting Hole Pattern for .062 [1.57] Thick PC Board Using a Straight Post Header

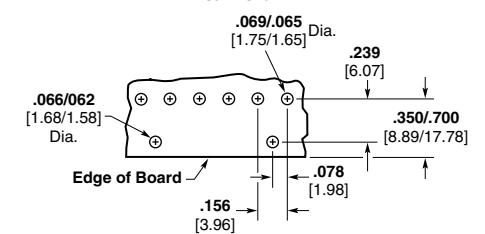

Recommended Mounting Hole Pattern for .062 [1.57] Thick PC Board Using a Right-Angle Header

Base Part Numbers

| Straight Square Posts | | | | Straight Round Posts | | | |
|--------------------------------------------------------|-------------|------------------|-------------|-------------------------------------------|-------------|------------------|-------------|
| Without Pegs | | With Pegs | | Without Pegs | | With Pegs | |
| Header Part Nos. | RoHS Equiv. | Header Part Nos. | RoHS Equiv. | Header Part Nos. | RoHS Equiv. | Header Part Nos. | RoHS Equiv. |
| Standard UL94V-0, Tin Plated | | | | | | | |
| 647123 | 22-32 | 647127 | 22-32 | 647124 | 22-32 | 647128 | 22-32 |
| Standard UL94V-0, .000030 [0.00076] Gold Plated | | | | | | | |
| 647131 | 22-32 | 647135 | 22-32 | 647132 | 22-32 | 647136 | 22-32 |
| Standard UL94V-0, .000015 [0.00038] Gold Plated | | | | | | | |
| 647139 | 22-32 | 647143 | 22-32 | 647140 | 22-32 | 647144 | 22-32 |
| Square Posts | | | | | | | |
| Right-Angle Posts, Front Bend Without Pegs | | | | Right-Angle Posts, Rear Bend Without Pegs | | | |
| Header Part Nos. | | RoHS Equiv. | | Header Part Nos. | | RoHS Equiv. | |
| Standard UL94V-0, Tin Plated | | | | | | | |
| 647125 | | 22-32 | | 647126 | | 22-32 | |
| Standard UL94V-0, .000030 [0.00076] Gold Plated | | | | | | | |
| 647133 | | 22-32 | | 647134 | | 22-32 | |
| Standard UL94V-0, .000015 [0.00038] Gold Plated | | | | | | | |
| 647141 | | 22-32 | | 647142 | | 22-32 | |

Note: Select load headers (omitted pin headers) are available upon request. Please contact product engineer or product manager for details.

MTA-156 IDC Quad Connectors

Product Facts

- Provides four points of contact
- Greater current carrying capability than Standard MTA-156 Connectors
- Connector styles include both closed end and feed-thru with locking ramp, with and without polarizing tabs in 2 through 12 positions
- Available for wire ranges of 18–22 AWG [0.9–0.3 mm²]
- Contacts are lubricated for fretting corrosion protection
- Complies with Tyco Electronics Quality Specification 102-6, “Preparation of Design Objectives”
- Uses existing MTA application tooling for termination
- Quad connectors preloaded with contacts
- All contacts are slotted for insulation displacement (IDC) termination technique
- Connectors and headers are end-to-end stackable
- AWG size is “frosted” on the side of the connector
- Recognized under the Component Program of Underwriters Laboratories Inc.,  File No. E28476
- Certified by Canadian Standards Association,  File No. LR 7189
- Satisfies the VDE requirements according to VDE 110, Insulation Group B, 250 vac for air and creepage paths

The MTA-156 Quad Connector provides a connection with four points of contact. The UL94V-0 rated connector with multi-point contacts provides greater current carrying capability than the Standard MTA-156 Connector. These connectors comply with Tyco Electronics Quality Specification 102-6* and satisfy the VDE requirements according to VDE 110.

The connectors are available for wire ranges of 18–22 AWG [0.9–0.3 mm²] and in a variety of styles including closed end and feed-thru with locking ramp, with and without polarizing tabs.

Only one wire to be terminated into an IDC contact slot.

*The 102-6 Quality Specification is the new procedure for “Preparation of Design Objectives”. Its purpose is to provide a means for verifying the maximum current carrying capacity of the device.

Note: Refer to pages 70 through 74 for approved wire listings.



The MTA-156 Quad Connectors only mate with standard MTA-156 square post headers and use existing MTA application tooling for termination.

Performance Data

- Voltage Rating** — 600 vac
- Current Rating** — 12.5 amp max. on a single circuit.
- For Multiple Circuit Loading** — refer to Product Specification for current rating chart.
- Low-Level Resistance** — 3.0 mΩ max. initial
- Dielectric Withstanding Voltage** — 1500 vac/1 min.
- Insulation Resistance** — 5000 MΩ min. initial
- Operating Temperature** — -55° C to +105° C

Technical Documents

Product Specifications

108-1219 MTA-156 Quad Connector System

Application Specifications

114-1048 MTA-156 Quad Connector

This matrix has been prepared to assist you, our customer, in defining the correct mating halves for the MTA-156 header and connector combination. Where a “Y” is indicated the combination is a valid mating pair.

Headers

| | 640383 | 640385 | 640389 | 640445 | 644611 | 644613 | 644615 | 644617 | 644749 | 644751 | 644752 | 644754 | 647123 | 647125 | 647126 | 647127 |
|--------|--------|--------|--------|--------|--------|--------|--------|--------|--------|--------|--------|--------|--------|--------|--------|--------|
| 644329 | Y | Y | Y | Y | Y | Y | Y | Y | Y | Y | Y | Y | Y | Y | Y | Y |
| 644370 | Y | Y | Y | Y | Y | Y | Y | Y | Y | Y | Y | Y | Y | Y | Y | Y |
| 644371 | Y | Y | Y | Y | Y | Y | Y | Y | Y | Y | Y | Y | Y | Y | Y | Y |
| 644375 | Y | Y | Y | Y | Y | Y | Y | Y | Y | Y | Y | Y | Y | Y | Y | Y |
| 644376 | Y | Y | Y | Y | Y | Y | Y | Y | Y | Y | Y | Y | Y | Y | Y | Y |
| 644377 | Y | Y | Y | Y | Y | Y | Y | Y | Y | Y | Y | Y | Y | Y | Y | Y |
| 644381 | Y | Y | Y | Y | Y | Y | Y | Y | Y | Y | Y | Y | Y | Y | Y | Y |
| 644382 | Y | Y | Y | Y | Y | Y | Y | Y | Y | Y | Y | Y | Y | Y | Y | Y |
| 644383 | Y | Y | Y | Y | Y | Y | Y | Y | Y | Y | Y | Y | Y | Y | Y | Y |
| 644387 | Y | Y | Y | Y | Y | Y | Y | Y | Y | Y | Y | Y | Y | Y | Y | Y |
| 644388 | Y | Y | Y | Y | Y | Y | Y | Y | Y | Y | Y | Y | Y | Y | Y | Y |
| 644389 | Y | Y | Y | Y | Y | Y | Y | Y | Y | Y | Y | Y | Y | Y | Y | Y |

MTA-156 .156 [3.96]

MTA-156 IDC Quad Connectors—Closed End and Feed-Thru

Closed End with Locking Ramp



Feed-Thru with Locking Ramp

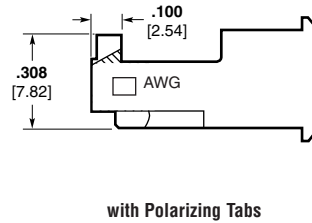

Material and Finish

Housing—UL94V-0 rated, nylon, black

Contacts—High conductivity copper alloy, post tin plated

For mateability options, see matrix on page 54.

For strain relief and dust covers, see pages 40 and 41.

For mating half visuals, see pages 46 thru 48 and 50, 52 and 53, (49 and 51 Front Bend Headers only). **Mates with tin-plated square posts only.**

Refer to pages 70 thru 74 for approved wire listing.

Note: To determine connector overall length (Dim. A), multiply .156 x the number of circuits. Example: .156 x 10 circuits equals 1.560 inches [39.62 mm].

Base Part Numbers

| Connector Type & Wire Size | Closed End with Locking Ramp | | | | Feed-Thru with Locking Ramp | | | |
|------------------------------------------|------------------------------|--------------|---------------------|--------------|-----------------------------|--------------|---------------------|--------------|
| | Without Tabs | | With Tabs | | Without Tabs | | With Tabs | |
| | Connector Part Nos. | RoHS Equiv. | Connector Part Nos. | RoHS Equiv. | Connector Part Nos. | RoHS Equiv. | Connector Part Nos. | RoHS Equiv. |
| Standard UL94V-0, Tin Plated | | | | | | | | |
| 18 AWG 0.8-0.9 mm ² | 644329 | 32-42 | 644381 | 32-42 | 644375 | 32-42 | 644387 | 32-42 |
| 20 AWG 0.5-0.6 mm ² | 644370 | 32-42 | 644382 | 32-42 | 644376 | 32-42 | 644388 | 32-42 |
| 22 AWG 0.3-0.4 mm ² | 644371 | 32-42 | 644383 | 32-42 | 644377 | 32-42 | 644389 | 32-42 |

Connector Ordering Information

The "Base Part Numbers" Chart above shows the base part number and number of circuits available for the described connectors.

Prefixes and suffixes are determined by the number of circuit positions in the connector. For example, the complete part number for a 10-position closed end connector with locking ramp and without polarizing tabs for 18 AWG wire would be:

Base number **644329** plus prefix-and-suffix **1- -0**

The correct ordering number is **1-644329-0**

The set of numbers in **bold face** are the RoHS equivalent version of the standard product. Example:

| No. of Pos. | Standard Prefix/Suffix | Lead Free RoHS Prefix/Suffix |
|-------------|------------------------|------------------------------|
| 2 | 644329-2 | 3-644329-2 |
| thru | | |
| 12 | 1-644329-2 | 4-644329-2 |

See page 15 for an explanation of RoHS lead free equivalents.

Note: All RoHS equivalent part numbers may not be available upon catalog release. If the number you need is not available, please contact Product Engineering to expedite your request.

Replacement IDC Contacts

Material and Finish

Contacts—High conductivity copper alloy post tin plated



| Wire Size | | Part Numbers |
|-----------|-----------------|--------------|
| AWG | mm ² | |
| 18 | 0.8-0.9 | 3-644508-1 |
| 20 | 0.5-0.6 | 3-644509-1 |
| 22 | 0.3-0.4 | 3-644510-1 |

Note: Tyco Electronics does not recommend terminating an MTA contact more than one time. Use replacement contacts when required for field repairs or wire gage changes.

MTA-156
.156 [3.96]

MTA-156 IDC Card Edge Accessories

Dust Cover

Material (RoHS Compliant)

UL94V-0 rated, polyester, white

Cover is for both Closed End and Feed-Thru connectors



Cover Ordering Information

The "Base Part Numbers" Chart at right shows the base part number and number of circuits available for the described cover.

Prefixes and suffixes are determined by the number of circuit positions in the cover. For example, the complete part number for a 12-position dust cover would be:

Base number **641106** plus prefix-and-suffix

1- — -2

The correct ordering number is

1-641106-2

Base Part Number

| Cover Part No. | No. of Circuits |
|----------------|----------------------------|
| 641106 | 3, 6, 9, 12, 15, 18, 20-24 |

| No. of Circuits | Dim. A | Prefix/Suffix |
|-----------------|----------------|---------------|
| 3 | .504 12.80 | -3 |
| 6 | .972 24.69 | -6 |
| 9 | 1.440 36.58 | -9 |
| 12 | 1.908 48.46 | 1- -2 |
| 15 | 2.376 60.35 | 1- -5 |
| 18 | 2.844 72.24 | 1- -8 |
| 20 | 3.156 80.16 | 2- -0 |
| 21 | 3.312 84.12 | 2- -1 |
| 22 | 3.468 88.09 | 2- -2 |
| 23 | 3.624 92.05 | 2- -3 |
| 24 | 3.780 96.01 | 2- -4 |

Replacement IDC Contacts

Material and Finish

Phosphor bronze; post tin plated

Part Numbers

- 3-640991-1 (18 AWG [0.8-0.9 mm²])
- 3-640992-1 (20 AWG [0.5-0.6 mm²])
- 3-640993-1 (22 AWG [0.3-0.4 mm²])
- 3-640994-1 (24 AWG [0.2 mm²])
- 3-640995-1 (26 AWG [0.12-0.15 mm²])



Locking Plugs

Material (RoHS Compliant)

UL94V-2 rated, nylon, white

Part Number 641101-1



Note: Contact must be removed to install locking plug.

Material (RoHS Compliant)

UL94V-2 rated, nylon, white

Part Number 641293-1



Note: Contact can remain during locking plug installation.

.156 [3.96] Centerline SL-156 Crimp Contacts and Housings

Product Facts

- Rugged wire-to-board interconnection to mate with .045 square or round post headers or staked posts on .156 centers
- Standard Connectors accept wire range of 18–24 AWG [0.9–0.2 mm²] and LID Connectors accept wire range of 18–24 AWG [0.9–0.2 mm²] and a limited 16 AWG [1.29–1.42 mm²] (2550–2800 CMA)
- Two-piece interconnection system (connector/header)
- Housing made of flame retardant nylon
- Available in 1- through 24-position connector configurations
- Connectors are end-to-end stackable
- Wire-to-board system offers polarization with friction lock for positive mating
- Meets the material requirements of Table 23.1 of UL1410 Standard for High-Voltage Television Receivers and Video Productions
- Recognized under the Component Program of Underwriters Laboratories Inc., File No. E28476
- Certified by Canadian Standards Association, File No. LR7189



Technical Documents

- Product Specification
108-1049, 108-1049-1, 108-1049-2
- Application Specification
114-1021

The AMP SL-156 connectors shown on the following pages are designed to mate with .045 [1.14] square or round post headers or staked posts on .156 [3.96] centers.

The wire-to-board connector is a two-piece connector system with the wire crimped to the contact, then inserted into the housing. This product mates with the MTA-156 flat, polarized and friction lock header, or staked posts (not MTA-156 shrouded headers).

Performance Data

- Voltage Rating** — 250 vac
- Current Rating** — 10 amp max. at 250 vac
- Low-Level Resistance** — 3.0 mΩ max. initial
- Dielectric Withstanding Voltage** — 2000 vac/1 min.
- Insulation Resistance** — 1000 MΩ min. initial
- Operating Temperature** — -55° C to +105° C

The Large Insulation Diameter (LID) Contacts and Housings are for use in applications where wire insulation is up to .112 [2.84] in diameter.

These matrixes represent only the housing and header combinations. You also need to consider the plating on the contacts and headers. Gold contacts with gold headers and tin contacts with tin headers.

Matrix for Tin Plated Part Numbers

| | | Headers | | | | | | | | | | | | | | | | | | | | | | | | | | | |
|----------|----------|---------|--------|--------|--------|--------|--------|--------|--------|--------|--------|--------|--------|--------|--------|--------|--------|--------|--------|--------|--------|--------|--------|--------|--------|--------|--------|--------|--------|
| Housings | Standard | LID | 640383 | 640384 | 640385 | 640387 | 640388 | 640389 | 640445 | 644611 | 644612 | 644613 | 644614 | 644615 | 644616 | 644617 | 644749 | 644750 | 644751 | 644752 | 644753 | 644754 | 644755 | 647227 | 647228 | 647229 | 647230 | 647260 | 647262 |
| | 640250 | 647401 | Y | Y | Y | N | Y | Y | Y | Y | Y | Y | N | Y | Y | Y | Y | Y | Y | Y | Y | Y | Y | N | Y | Y | Y | Y | Y |
| 640251 | 647400 | Y | Y | Y | Y | Y | Y | Y | Y | Y | Y | Y | Y | Y | Y | Y | Y | Y | Y | Y | Y | Y | Y | Y | Y | Y | Y | Y | Y |
| 770849 | 647402 | Y | Y | Y | N | Y | Y | Y | Y | Y | Y | N | Y | Y | Y | Y | Y | Y | Y | Y | Y | Y | N | Y | Y | Y | N | Y | Y |

Matrix for .000030 [0.00076] Gold Plated Part Numbers

| | | Headers | | | | | | | | | | | | | | | | | | | | | | | |
|----------|----------|---------|--------|--------|--------|--------|--------|--------|--------|--------|--------|--------|--------|--------|--------|--------|--------|--------|--------|--------|--------|--------|--------|---|--|
| Housings | Standard | LID | 641202 | 641203 | 641204 | 641207 | 641208 | 641209 | 641210 | 644627 | 644628 | 644629 | 644630 | 644631 | 644632 | 644633 | 644756 | 644757 | 644758 | 644759 | 644760 | 644761 | 644762 | | |
| | 640250 | 647401 | Y | Y | Y | N | Y | Y | Y | Y | Y | Y | N | Y | Y | Y | Y | Y | Y | Y | Y | Y | Y | N | |
| 640251 | 647400 | Y | Y | Y | Y | Y | Y | Y | Y | Y | Y | Y | Y | Y | Y | Y | Y | Y | Y | Y | Y | Y | Y | | |
| 770849 | 647402 | Y | Y | Y | N | Y | Y | Y | Y | Y | Y | N | Y | Y | Y | Y | Y | Y | Y | Y | Y | Y | N | | |

Matrix for .000015 [0.00038] Gold Plated Part Numbers

| | | Headers | | | | | | | | | | | | | | | | | | | | | | | |
|----------|----------|---------|--------|--------|--------|--------|--------|--------|--------|--------|--------|--------|--------|--------|--------|--------|--------|--------|--|--|--|--|--|--|--|
| Housings | Standard | LID | 641113 | 641114 | 641115 | 641118 | 641119 | 641120 | 641121 | 644322 | 644763 | 644764 | 644765 | 644766 | 644767 | 644768 | 644769 | 647261 | | | | | | | |
| | 640250 | 647401 | Y | Y | Y | N | Y | Y | Y | Y | Y | Y | Y | Y | Y | Y | N | Y | | | | | | | |
| 640251 | 647400 | Y | Y | Y | Y | Y | Y | Y | Y | Y | Y | Y | Y | Y | Y | Y | Y | | | | | | | | |
| 770849 | 647402 | Y | Y | Y | N | Y | Y | Y | Y | Y | Y | Y | Y | Y | Y | N | Y | | | | | | | | |

SL-156 Crimp Contacts and Keying Plugs

Contacts

Material and Finish

.012 [0.3] bright tin plated brass or phosphor bronze; .012 [0.3] pre-tin brass; or .012 [0.3] brass or phosphor bronze with .000030 [0.00076] gold over nickel (see chart)

- All tin-plated contacts are post lubricated to resist fretting corrosion
- Maximum insulation diameter is .105 [2.67]
- Wire range is 18-30 AWG [0.9-0.06 mm²]



Application Note

Part No. 640252 has a higher mating and unmating force than Part No. 350980 and is recommended to be used only in housings with 1 through 12 positions.

Part No. 350980 can be used in any size housing but is recommended to be used in housings with 13 through 24 positions.

Part No. 770476 is recommended for use in any size housing. Its mating force is similar to Part No. 350980 while unmating force is similar to 640252.

For housings, see pages 60 and 61.

Keying Plugs

Material (RoHS Compliant)

UL94V-2 rated, nylon, natural color



Keying Plug
Part No. 640254-1



Keying Pin
Part No. 640255-1

| Wire Size AWG mm ² | Contact | Material and Finish | Part Numbers | |
|----------------------------------|---------|----------------------------------------|--------------|-------------|
| | | | Strip | Loose Piece |
| 24-30 0.2-0.06 | A | brass, pre-tin plated | 641550-1 | — |
| | | brass, bright tin plated | 640252-1 | 640706-1 |
| | | brass, pre-tin plated | 640252-2 | 640706-2 |
| 18-24 0.9-0.2 | A | brass, RoHS Compliant | 3-640252-1 | 3-640706-1 |
| | | brass, bright tin plated | 350980-1 | 640707-1 |
| | | brass, pre-tin plated | 350980-2 | — |
| | B | brass, gold plated | 350980-3 | 770258-1 |
| | | brass, RoHS Compliant | 3-350980-1 | 3-640707-1 |
| | | phosphor bronze, bright tin plated | 770476-1 | 770522-1 |
| | C | phosphor bronze, gold plated | 770476-2 | 770522-2 |
| | | phosphor bronze, RoHS Compliant | 3-770476-1 | 3-770522-1 |

Application Tooling

Extraction Tool
Part No. 90471-1

Loose Piece Contacts —

PRO-CRIMPER II Hand Tool
Part No. 58614-1 (408-4228)
[For field service use only]
For CERTI-CRIMP hand tool, contact
Technical Support.

Strip Contacts —

AMP-O-LECTRIC Model "G"
Termination Machine*
Applicator 680211-3
(Request Catalog 65828)
AMP-O-LECTRIC Model "K"
Termination Machine* Applicator
466468-2
AMP-O-MATIC Stripper-Crimper
Machine* SCA 466947-1 or 567828-1
(with CQM) (Request Catalog 65004)
AMPOMATOR CLS IV+ Lead Making
Machine* Applicator 466468-1
(Request Catalog 82659)

*Requires applicators. For part numbers, call Technical Support.

SL-156 Housings—Wire-to-Board

Housings

Material (RoHS Compliant)

UL94V-0 rated, nylon, white

Notes:

1. Accepts either .045 [1.14] square or round posts. Housings mate with flat and friction lock headers, or staked posts on .156 [3.96] centers.
2. Housings without ramp, with polarizing tab, available upon request. Minimums may apply.
3. Recommend contact: Part No. 640252 for 1 thru 12 positions; Part No. 350980 for 13 thru 24 positions; Part No. 770476 for 1 thru 24 positions.



(A) With Locking Ramp/With Polarizing Tabs



(B) With Locking Ramp/Without Polarizing Tabs



(C) Without Locking Ramp/Without Polarizing Tabs

Note: Dim. A = 0.156 × (No. of Positions – 1) + 0.152

For contacts, see page 59.

For mateability options, see matrix on page 58.

For mating half visuals, for connectors with locking ramp, see pages 46, 47, 48, 50 and 52, (49 and 51 Front Bend Headers only.)

For mating half visuals, for connectors without locking ramp, see pages 46 thru 52.

| No. of Positions* | Housing | Description | Part Numbers* |
|-------------------|---------|-----------------------------------------------|---------------|
| 2–24 | A | With Locking Ramp and Polarizing Tabs | 770849 |
| 1–24 | B | With Locking Ramp and without Polarizing Tabs | 640250 |
| | C | Without Locking Ramp or Polarizing Tabs | 640251 |

*Base Part Number Prefixes and Suffixes indicate number of contact positions, e.g. 2 Position = 0-xxxxx-2 and 12 Position = 1-xxxxx-2.

Note: Housings not for use with LID Contacts. Shown on page 62.

SL-156
.156 [3.96]

SL-156 Housings With Through Board Latch

Housings

Material (RoHS Compliant)

UL94V-2 rated, nylon, white

Mates with .045 square or
round staked posts only.

For contacts, see page 59



Recommended PC Board Cutout
for .062 [1.57] Thick PC Board

| No. of Pos. | Dimensions | | Latch Location Centered Between Pos. | Part Number |
|-------------|----------------|----------------|--------------------------------------|-------------|
| | A | B | | |
| 2 | .312 7.92 | — | 1 and 2 | 770894-2 |
| 3 | .468 11.89 | — | 1 and 2 | 770894-3 |
| 4 | .624 15.85 | — | 2 and 3 | 770894-4 |
| 5 | .780 19.81 | — | 2 and 3 | 770894-5 |
| 6 | .936 23.77 | — | 3 and 4 | 770894-6 |
| 7 | 1.092 27.74 | — | 3 and 4 | 770894-7 |
| 8 | 1.248 31.70 | — | 4 and 5 | 770894-8 |
| 9 | 1.404 35.66 | 1.092 27.74 | 1 and 2 & 8 and 9 | 770894-9 |
| 10 | 1.560 39.62 | 1.248 31.70 | 1 and 2 & 9 and 10 | 1-770894-0 |

Note: Not for use with LID Contacts. Shown on page 62.

SL-156
.156 [3.96]

SL-156 Housings and Contacts for Large Insulation Diameter (LID) Wire

Housings

Material (RoHS Compliant)

UL 94V-0 rated, nylon, white

Notes:

1. Accepts Standard and LID contacts.
2. Larger opening in housings eases contact insertion when using wires that have large insulation diameters (.100-.112 [2.54-2.84]).
3. Housings are not End-to-End stackable.

For mateability options, see matrix on page 58.

For mating half visuals, for connectors with locking ramp, see pages 46, 47, 48, 50 and 52, (49 and 51 Front Bend Headers only.)

For mating half visuals, for connectors without locking ramp, see pages 46 thru 52.



Note: Dim. A = 0.156 × (No. of Positions – 1) + 0.19

| No. of Positions* | Description | Part Numbers* |
|-------------------|-----------------------------------------------|-------------------------------------------------|
| | | Housings with Larger Openings for Oversize Wire |
| 1-24 | Without Locking Ramp or Polarizing Tabs | 647400 |
| | With Locking Ramp and without Polarizing Tabs | 647401 (shown above) |
| 2-24 | With Locking Ramp and Polarizing Tabs | 647402 |

*Base Part Number Prefixes and Suffixes indicate number of contact positions, e.g. 2 Position = 0-xxxxx-2 and 12 Position = 1-xxxxx-2.

Contacts

Material and Finish

.012 [0.3] bright tin plated phosphor bronze; .012 [0.3] phosphor bronze with .000030 [0.00076] gold over nickel (see chart)

- All tin-plated contacts are post lubricated to resist fretting corrosion
- Maximum insulation diameter is .112 [2.85]
- Wire range is 18-24 AWG [0.9-0.2 mm²] and a limited 16 AWG [1.29-1.42 mm²] (2550-2800 CMA)



Hooded (Dual Wipe)
(10 Amp Max. Current Rating)

Product Specifications

108-1049-1 and 108-1049-2

Application Specification

114-1021

Application Tooling

Extraction Tool Part No. 90471-1

Loose Piece Contacts —

PRO-CRIMPER II Hand Tool

Part No. 91368-1 [18-24 AWG]

Part No. 91369-1 [16 AWG]

(For field service use only.)

For CERTI-CRIMP hand tool, contact Technical Support.

Strip Contacts —

AMP-O-LECTRIC Model "G"

Termination Machine*

Applicator 1385048-3 [18-24 AWG]

Applicator 1385219-3 [16 AWG]

AMP-O-LECTRIC Model "K"

Termination Machine*

Applicator 1385048-2 [18-24 AWG]

Applicator 1385219-2 [16 AWG]

| Wire Size | Material | Plating | Part Numbers For LID* Wire | |
|--------------------------------|-----------------|----------------|----------------------------|-------------|
| | | | Strip | Loose Piece |
| 18-24 AWG | Phosphor Bronze | Tin | 647406-1 | 647409-1 |
| | | Gold | 647406-2 | 647409-2 |
| | | RoHS Compliant | 3-647406-1 | 3-647409-1 |
| 16 AWG (2550-2800 CMA only) | Phosphor Bronze | Tin | 647466-1 | 647485-1 |
| | | Gold | 647466-2 | 647485-2 |
| | | RoHS Compliant | 3-647466-1 | 3-647485-1 |

*Large Insulation Diameter (.100-.112 [2.54-2.84])

Notes: 1. For information on application tooling, call Technical Support.

2. Can **not** be used with Standard SL-156 Housings, must be used with LID Housings only.

*For additional part numbers and information contact Technical Support.

SL-156
.156 [3.96]

AMP Economy Power (EP) Wire-to-Board Connector System

Product Facts

- .156 [3.96], .200 [5.08] and .312 [7.92] centerline
- Wire-to-board connectors comprised of plug housings, receptacle contacts for discrete wire, and mating post headers
- Hooded contact designed to accept wire with insulation diameters up to .118 [3.00]
- Positive locking feature built into header back wall
- Locking mechanism on connector housing maximizes retention
- Number of positions: 1 to 11 for .156 [3.96] centerline; 2 to 12 for .200 [5.08] centerline; and 2 to 5 for .312 [7.92] centerline
- Straight, through-hole headers
- Positive latch design for easier mating and unmating
- Polarization tabs help prevent post misalignment and mismatching
- Low-profile mating height of .641 [16.3] for 2 to 11 positions
- Straight headers are end-to-end stackable to conserve PCB space
- Header packaging: bulk pack and tube loaded
- Plug housings and post headers intermateable with JST VH connectors
- Directive 2002/95/EC (RoHS Compliant)
- Recognized under the Component Program of Underwriters Laboratories Inc., File No. E28476 
- Certified by Canadian Standards Association, File No. LR 7189 

Applications

- Household appliances, garage door openers, power supplies, power connections, or other areas requiring additional connector retention



AMP Economy Power (EP) Connectors are designed for secondary power circuit applications. They consist of wire-to-pc board plug housings (for receptacle contacts) and mating post headers. Three contact centerline spacings are available: .156 [3.96], .200 [5.08] and .312 [7.92].

During mating, the positive locking lever on the outside of the plug housing engages the mating header housing to provide for greater retention. This helps maintain reliable connections, when other non-locking type connectors could vibrate apart. This same locking lever must be depressed to unmate the connectors.

The locking mechanism is also located high enough to help avoid interference with pc board clear plastic coating (potting), which is a common treatment for many home appliances.

Headers with .156 [3.96] centerline are offered in 2 through 11 positions; 2 through 12 positions for .200 [5.08] centerline; and .312 [7.92] centerline are available in 2 through 5 positions. Both versions are provided in bulk pack or in tubes for automatic machines.

The slim, straight, post headers are stackable end-to-end for greater flexibility when designing pc board configurations.

The mating height of a low-profile plug and vertical header is .642 [16.3]; even the 1-position high-profile style measures only .732 [18.6] above the pc board. Compact dimensions like these are well suited for most applications in confined spaces.

Performance Characteristics

Voltage Rating — 250 VAC

Current Rating — 7.5 amp max. (2 to 11 pos.), 8 amp max. (1 pos.)

Low Level Overall Resistance—
Initial — 10 mΩ max.

Final — 20 mΩ max.

Dielectric Withstanding Voltage —
1.5 kV AC, 1 min.

Insulation Resistance —

Initial — 1000 MΩ min.

Final — 500 MΩ min.

Durability — 50 mating and unmating cycles

Operating Temperature — -13°F to +221°F [-25°C to +105°C]

Wire Size Range — 18-22 AWG
[0.89-0.30 mm²]

Insulation Diameter — .118 [3.00] max.

Technical Documents

Product Specification

108-5609

Application Specification

114-5253

Instruction Sheet

411-5899

AMP Economy Power (EP) Wire-to-Board Connector System (Continued)

Contacts and Plug Housings, Low-Profile

Crimp, Snap-in Receptacle Contacts

Material and Finish (RoHS Compliant)

See chart.

Related Product Data

Plug Housings — Pages 64, 67 and 69

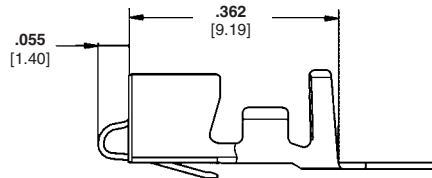
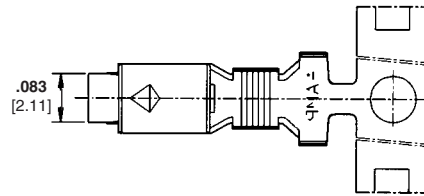

| Wire Size Range | | Wire Insulation Diameter | Material and Finish | Part Number | | Applicator Part Number | | |
|-----------------|-----------------|--------------------------|---------------------|-------------|-------------|---------------------------------------------------|------------------------------------------------------|---------------------------|
| AWG | mm ² | | | Strip Form | Loose Piece | AMPOMATOR CLS IV+ Lead Maker Base Part No. 356500 | AMP-O-LECTRIC Terminator Model K Part No. 1-471273-3 | Model G Part No. 354500-1 |
| 18-22 | 0.89-0.30 | .067-.118 1.70-3.00 | Phos. Brz., Pre-Tin | 1123721-1 | 1318912-1* | 1385286-1 | 1385286-2 | 1385286-3 |
| | | | Brass, Pre-Tin | 1123721-2 | — | | | |

* For 18-20 AWG, use Straight Action Hand Tool (SAHT) Part Number 91579-1.

Plug Housings, Low-Profile

Material and Finish (RoHS Compliant)

Housing — UL 94V-0 rated nylon, natural color

Note: Alternate colors available upon request. Minimums may apply. Please contact product engineer or product manager for details.

Related Product Data

Contacts — see above

Mating Post Headers — Pages 65 and 66

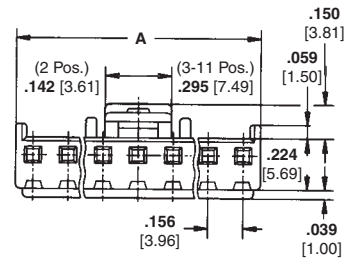
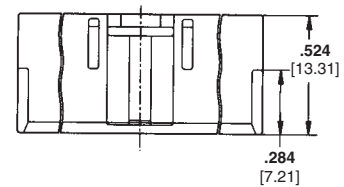
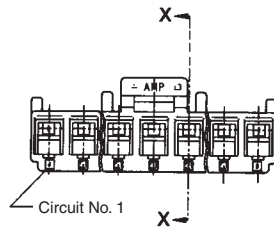

| Number of Positions | Dimension A | Part Number |
|---------------------|---------------|-------------|
| 2 | .310 [7.86] | 1-1123722-2 |
| 3 | .465 [11.82] | 1-1123722-3 |
| 4 | .621 [15.78] | 1-1123722-4 |
| 5 | .777 [19.74] | 1-1123722-5 |
| 6 | .933 [23.70] | 1-1123722-6 |
| 7 | 1.089 [27.66] | 1-1123722-7 |
| 8 | 1.245 [31.62] | 1-1123722-8 |
| 9 | 1.401 [35.58] | 1-1123722-9 |
| 10 | 1.557 [39.54] | 1-1123722-0 |
| 11 | 1.713 [43.50] | 1-1123722-1 |
| 12 | 1.878 [47.70] | 1-647690-2* |

* Consult Product Drawing for dimensional detail.

AMP EP
.156 [3.96]

AMP Economy Power (EP) Wire-to-Board Connector System (Continued)

Straight and Right-Angle Low-Profile Post Headers

.156 [3.96] Centerline

Material and Finish (RoHS Compliant)

Housing — UL 94V-0 rated natural color

Note: Alternate colors available upon request. Minimums may apply. Please contact product engineer or product manager for details.

Post — Tin-plated brass

Straight



Related Product Data

Mating Plug Housings — Page 64

| Number of Positions | Dimension A | Part Number | | |
|---------------------|---------------|-------------|-----------------------------|---------------------|
| | | Bulk Pack | Tube Loaded (Pcs. per Tube) | Bulk Pack with Pegs |
| 2 | .310 [7.86] | 1-1123723-2 | 1-1318300-2 (61) | 1744057-2 |
| 3 | .465 [11.82] | 1-1123723-3 | 1-1318300-3 (40) | 1744057-3 |
| 4 | .621 [15.78] | 1-1123723-4 | 1-1318300-4 (30) | 1744057-4 |
| 5 | .777 [19.74] | 1-1123723-5 | 1-1318300-5 (24) | 1744057-5 |
| 6 | .933 [23.70] | 1-1123723-6 | 1-1318300-6 (20) | 1744057-6 |
| 7 | 1.089 [27.66] | 1-1123723-7 | 1-1318300-7 (17) | 1744057-7 |
| 8 | 1.245 [31.62] | 1-1123723-8 | 1-1318300-8 (15) | 1744057-8 |
| 9 | 1.401 [35.58] | 1-1123723-9 | 1-1318300-9 (13) | 1744057-9 |
| 10 | 1.557 [39.54] | 1-1123723-0 | 1-1318300-0 (12) | 1-1744057-0 |
| 11 | 1.713 [43.50] | 1-1123723-1 | 1-1318300-1 (11) | 1-1744057-1 |
| 12 | 1.871 [47.52] | 1-647689-2* | — | 1-1744057-2 |

* Consult Product Drawing for dimensional detail.

.156 [3.96] Centerline

Material and Finish (RoHS Compliant)

Housing — UL 94V-0 rated nylon, natural color

Note: Alternate colors available upon request. Minimums may apply. Please contact product engineer or product manager for details.

Post — Tin-plated brass

Right-Angle



Related Product Data

Mating Plug Housings — Page 64

| Number of Positions | Dimension A | Part Number |
|---------------------|---------------|-------------|
| 2 | .312 [7.92] | 647676-2 |
| 3 | .468 [11.88] | 647676-3 |
| 4 | .624 [15.84] | 647676-4 |
| 5 | .780 [19.80] | 647676-5 |
| 6 | .935 [23.76] | 647676-6 |
| 7 | 1.091 [27.72] | 647676-7 |
| 8 | 1.247 [31.68] | 647676-8 |
| 9 | 1.403 [35.64] | 647676-9 |
| 10 | 1.559 [39.60] | 1-647676-0 |
| 11 | 1.715 [43.56] | 1-647676-1 |
| 12 | 1.871 [47.52] | 1-647676-2 |

AMP Economy Power (EP) Wire-to-Board Connector System (Continued)

**Straight and Right-Angle
Low-Profile Post Headers,
High Temperature**

.156 [3.96] Centerline

**Material and Finish
(RoHS Compliant)**

Housing — UL 94V-0 rated nylon,
high temperature, natural color

Note: Alternate colors available upon
request. Minimums may apply. Please
contact product engineer or product
manager for details.

Post — Tin-plated brass

Related Product Data

Mating Plug Housings — Page 64

Straight



| Number of Positions | Dimension A | Part Number |
|---------------------|---------------|-------------|
| 2 | .312 [7.92] | 1744055-2 |
| 3 | .468 [11.88] | 1744055-3 |
| 4 | .624 [15.84] | 1744055-4 |
| 5 | .780 [19.80] | 1744055-5 |
| 6 | .935 [23.76] | 1744055-6 |
| 7 | 1.091 [27.72] | 1744055-7 |
| 8 | 1.247 [31.68] | 1744055-8 |
| 9 | 1.403 [35.64] | 1744055-9 |
| 10 | 1.559 [39.60] | 1-1744055-0 |
| 11 | 1.715 [43.56] | 1-1744055-1 |

Right-Angle



| Number of Positions | Dimension A | Part Number |
|---------------------|---------------|-------------|
| 2 | .312 [7.92] | 1744056-2 |
| 3 | .468 [11.88] | 1744056-3 |
| 4 | .624 [15.84] | 1744056-4 |
| 5 | .780 [19.80] | 1744056-5 |
| 6 | .935 [23.76] | 1744056-6 |
| 7 | 1.091 [27.72] | 1744056-7 |
| 8 | 1.247 [31.68] | 1744056-8 |
| 9 | 1.403 [35.64] | 1744056-9 |
| 10 | 1.559 [39.60] | 1-1744056-0 |
| 11 | 1.715 [43.56] | 1-1744056-1 |
| 12 | 1.871 [47.52] | 1-1744056-2 |

AMP EP
.156 [3.96]

AMP Economy Power (EP) Wire-to-Board Connector System (Continued)

Plug Housings and Post Headers

Plug Housings .200 [5.08] Centerline

Material and Finish (RoHS Compliant)

Housing — UL 94V-0 rated nylon, natural color

Note: Alternate colors available upon request. Minimums may apply. Please contact product engineer or product manager for details.

Related Product Data

Contacts — Page 64

Mating Post Headers — See below



| Number of Positions | Dimension A | Part Number |
|---------------------|---------------|-------------|
| 2 | .353 [8.98] | 1744036-2 |
| 3 | .553 [14.06] | 1744036-3 |
| 4 | .753 [19.14] | 1744036-4 |
| 5 | .953 [24.22] | 1744036-5 |
| 6 | 1.153 [29.30] | 1744036-6 |
| 7 | 1.353 [34.38] | 1744036-7 |
| 8 | 1.553 [39.46] | 1744036-8 |
| 9 | 1.753 [44.54] | 1744036-9 |
| 10 | 1.953 [49.62] | 1-1744036-0 |
| 11 | 2.153 [54.70] | 1-1744036-1 |
| 12 | 2.353 [59.78] | 1-1744036-2 |

Post Headers .200 [5.08] Centerline

Material and Finish (RoHS Compliant)

Housing — UL 94V-0 rated nylon, natural color

Note: Alternate colors available upon request. Minimums may apply. Please contact product engineer or product manager for details.

Post—Tin-plated brass



Related Product Data

Mating Plug Housings — See above



| Number of Positions | Dimension A | Part Number | |
|---------------------|---------------|-------------|-------------|
| | | Straight | Right-Angle |
| 2 | .302 [7.68] | 1744037-2 | 1744048-2 |
| 3 | .502 [12.76] | 1744037-3 | 1744048-3 |
| 4 | .702 [17.84] | 1744037-4 | 1744048-4 |
| 5 | .902 [22.92] | 1744037-5 | 1744048-5 |
| 6 | 1.102 [28.00] | 1744037-6 | 1744048-6 |
| 7 | 1.302 [33.08] | 1744037-7 | 1744048-7 |
| 8 | 1.502 [38.16] | 1744037-8 | 1744048-8 |
| 9 | 1.702 [43.24] | 1744037-9 | 1744048-9 |
| 10 | 1.902 [48.32] | 1-1744037-0 | 1-1744048-0 |
| 11 | 2.102 [53.40] | 1-1744037-1 | 1-1744048-1 |
| 12 | 2.302 [58.48] | 1-1744037-2 | 1-1744048-2 |

AMP Economy Power (EP) Wire-to-Board Connector System (Continued)

**Straight Post Headers,
Low-Profile**

.312 [7.92] Centerline

**Material and Finish
(RoHS Compliant)**

Housing — UL 94V-0 rated natural color

Note: Alternate colors available upon request. Minimums may apply. Please contact product engineer or product manager for details.

Post — Tin-plated brass

Related Product Data

Mating Plug Housings — Page 64



| Number of Positions | Dimension A | Part Number | |
|---------------------|---------------|-------------|-----------------------------|
| | | Bulk Pack | Tube Loaded (Pcs. per Tube) |
| 2 | .465 [11.82] | 1-1123724-2 | 1-1318301-2 (40) |
| 3 | .777 [19.74] | 1-1123724-3 | 1-1318301-3 (24) |
| 4 | 1.089 [27.66] | 1-1123724-4 | 1-1318301-4 (17) |
| 5 | 1.401 [35.58] | 1-1123724-5 | 1-1318301-5 (13) |

AMP EP
.312 [7.92]

**Mating Height
(Low-Profile)**



AMP Economy Power (EP) Wire-to-Board Connector System (Continued)

Plug Housing and Post Header, High-Profile

**1 Position Plug Housing
Part Number 1-1123823-1**

**Material and Finish
(RoHS Compliant)**

Housing — UL 94V-0 rated nylon, natural color

Note: Alternate colors available upon request. Minimums may apply. Please contact product engineer or product manager for details.



Related Product Data

Contacts — Page 64

Mating Post Header — See below

**1 Position Post Header,
Straight
Part Numbers
1-1123824-1 (Bulk Pack)
1-1318831-1 (Tube Loaded,
55 pcs. per Tube)**

**Material and Finish
(RoHS Compliant)**

Housing — UL 94V-0 rated nylon, natural color

Note: Alternate colors available upon request. Minimums may apply. Please contact product engineer or product manager for details.

Post — Tin-plated brass



Related Product Data

Mating Plug Housing — See above



Component Mounting Side



Soldering Side

**Mating Height
(High-Profile)**



MTA Wire Selection

Proper wire selection is critical to the success of a wire-to-board application. The chart identifies wires that have been evaluated and approved by the product engineering section. If you plan to use a wire not on the approved list, please submit a sample 12" length of wire to Tyco Electronics for evaluation.

AWG Metric Equivalents

18—0.8—0.9 mm²
20—0.5—0.6 mm²
22—0.3—0.4 mm²
24—0.2 mm²
26—0.12—0.15 mm²
28—0.08—0.09 mm²

Product Specifications

108-1050 — MTA-100 Connectors
108-1050-1 — MTA-100 Posted Connectors
108-1051 — MTA-156 Connectors
108-1219 — MTA-156 Quad Connector System
108-1065 — MTA-156 Posted Connectors
108-1058 — MTA-156 Card Edge Connectors

Application Specifications

114-1019 — MTA-100 Connectors
114-1020 — MTA-156 Connectors
114-1031 — MTA-100 Ribbon Cable Connector Assembly
114-1032 — MTA-156 Ribbon Cable Connector Assembly
114-1048 — MTA-156 Quad Connector

MTA Connectors Approved Wire Listing

| MTA-100 Connectors | Wall | Approved Wire AWG |
|------------------------------------------|---------------|-------------------|
| UL 1007 PVC Insulation | .015" [0.381] | 22, 24, 26, 28 |
| UL 1061 Semi-Rigid PVC Insulation | .009" [0.229] | 22, 24, 26, 28 |
| UL 1095 Semi-Rigid PVC Insulation | .012" [0.305] | 24 |
| UL 1371 TEFLON Insulation—TFE | .006" [0.152] | 22, 26 |
| UL 1429 Irradiated PVC—X.L.P.V.C. | .010" [0.254] | 22, 24, 26, 28 |
| UL 2464 PVC | .013" [0.330] | 24 |
| UL 3265 Irradiated Polyethylene—X.L.P.E. | .010" [0.254] | 22, 24 |
| UL 3266 Irradiated Polyethylene—X.L.P.E. | .015" [0.381] | 22, 24 |
| MIL-W-16878, Type B-PVC Insulation | .010" [0.254] | 22 |
| UL 1213 TEFLON Insulation—T.F.E. | .010" [0.254] | 22 |
| MTA-156 Connectors | | |
| UL 1007 PVC Insulation | .015" [0.381] | 18, 20, 22, 24 |
| UL 1061 Semi-Rigid PVC Insulation | .009" [0.229] | 18, 20, 22, 24 |
| UL 1180 TEFLON Insulation—T.F.E. | .015" [0.381] | 22 |
| UL 1213 TEFLON Insulation—T.F.E. | .010" [0.254] | 18, 22, 24 |
| UL 1316 PVC/Nylon Wall | .015" [0.381] | 18, 22 |
| UL 1429 Irradiated PVC—X.L.P.V.C. | .010" [0.254] | 18, 20, 22, 24 |
| UL 1430 Irradiated PVC—X.L.P.V.C. | .015" [0.381] | 18, 20, 22, 24 |
| UL 1569 PVC | .015" [0.381] | 18 |
| UL 3265 Irradiated Polyethylene—X.L.P.E. | .010" [0.254] | 22 |
| UL 3266 Irradiated Polyethylene—X.L.P.E. | .015" [0.381] | 18, 20, 22, 24 |

Note: When selecting approved wire styles noted on this list, the MTA Application Specifications guidelines must be followed. Also, due to wire variations in insulation wall thickness, hardness and wire stranding we would recommend evaluating the wire selected before final application approval.

TEFLON is a trademark of E.I. DuPont de Nemours and Company.

MTA-100 Ribbon Cable Preparation



MTA-156 Ribbon Cable Preparation



† The dimensions shown represent the recommended minimum and maximum for notches; the actual dimension will depend on your application requirements.

Notes:

- Cable shall be notched, as indicated in the individual ribbon cable connector assembly drawing, according to the requirements specified in these figures. Conductor shall not be exposed after notching, nor shall individual wire stands be cut or nicked.
- U.L. Style #2651 ribbon cable is approved for use with MTA-100 and MTA-156 connectors per Application Specification 114-1031 and 114-1032.

Ribbon Cable



Notes:

- For MTA Cable Assemblies Contact US Engineering Cable Assembly Group.
- For IDC Cable, see pages 71 thru 74.

IDC Ribbon Cable

Product Facts

- Compatible with a variety of Insulation Displacement Connectors
- Available on .025 [0.63], .0394 [1.00], .050 [1.27], .100 [2.54] and .156 [3.96] centerline
- Color code edge mark on conductor #1
- Gray flame retardant flexible PVC insulation
- Insulation rated for temperature of -20°C to +105°C
- Recognized under the Component Program of Underwriters Laboratories Inc.,
File No. E53793 



Tyco Electronics Corporation has an expanding array of MADISON CABLE planar PVC insulated product designed for compatibility with a variety of Insulation Displacement Connectors. AMP IDC terminations offer a quick, reliable, cost-effective cabling system which can be automated.

The .100 [2.54] centerline cable is available in 28 to 22 AWG, either as tinned or as overcoated tinned wire, in 2 to 28 conductors.

The .156 [3.96] centerline is available in 22 AWG and 18 AWG, either as tinned or overcoated tinned, in 2 to 24 conductors.

IDC Ribbon Cable is produced to tighter standards than usually required for high yield insulation displacement terminations. The extra precision offers uncomplicated operation in fully automatic stripping, notching and termination equipment.

Product Specifications

Voltage Rating — 30 VAC
Component Recognized by UL to US and Canadian Standards —
AWM Style 2651

Sizes —

26 AWG, 7/34 Tinned copper, PVC insulation (9 – 64 conductors), 500-ft reels (Base AMP Part Number 57034)

28 AWG, 7/36 Tinned copper, PVC insulation (9 – 64 conductors), 100-ft reels (Base AMP Part Number 57040) and 500-ft reels (Base AMP Part Number 971111)

30 AWG, Other conductor counts available on request. For ordering information, call Toll-Free: **1-877-623-4766** or visit: <http://www.madisoncable.com/fsproducts.htm>

.050 [1.27] Centerline, IDC Ribbon Cable

.100 [2.54] Centerline, IDC Ribbon Cable, PVC Insulation

Product Specifications

Voltage Rating — 300 Volts
UL Recognized — AWM Style 2651
CSA — Available on request

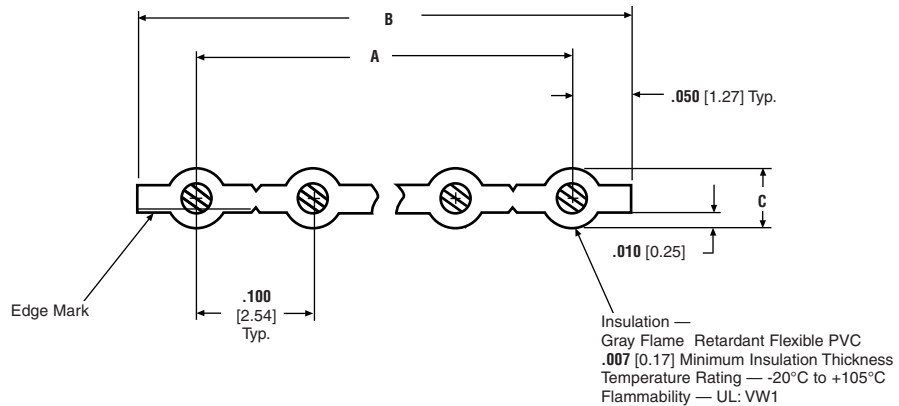

| No. of Conductors | Dimensions | | | Part Number |
|---------------------------------------------|---------------|---------------|--------------|--------------|
| | A | B | C | |
| 28 AWG 7/32 Tinned Copper | | | | |
| 2 | 0.100 [2.54] | 0.200 [5.08] | 0.044 [1.12] | 02WIFY00006P |
| 5 | 0.400 [10.16] | 0.500 [12.70] | 0.044 [1.12] | 05WIFY00006P |
| 10 | 0.900 [22.86] | 1.000 [25.40] | 0.044 [1.12] | 10WIFY00006P |
| 15 | 1.400 [35.56] | 1.500 [38.10] | 0.044 [1.12] | 15WIFY00006P |
| 20 | 1.900 [48.26] | 2.000 [50.80] | 0.044 [1.12] | 20WIFY00006P |
| 25 | 2.400 [60.96] | 2.500 [63.50] | 0.044 [1.12] | 25WIFY00006P |
| 28 | 2.700 [68.58] | 2.800 [71.12] | 0.044 [1.12] | 28WIFY00006P |
| 26 AWG 7/34 Tinned Copper | | | | |
| 2 | 0.100 [2.54] | 0.200 [5.08] | 0.039 [.99] | 02WEY00008P |
| 5 | 0.400 [10.16] | 0.500 [12.70] | 0.039 [.99] | 05WEY00004P |
| 10 | 0.900 [22.86] | 1.000 [25.40] | 0.039 [.99] | 10WEY00012P |
| 15 | 1.400 [35.56] | 1.500 [38.10] | 0.039 [.99] | 15WEY00002P |
| 20 | 1.900 [48.26] | 2.000 [50.80] | 0.039 [.99] | 20WEY00008P |
| 25 | 2.400 [60.96] | 2.500 [63.50] | 0.039 [.99] | 25WEY00008P |
| 28 | 2.700 [68.58] | 2.800 [71.12] | 0.039 [.99] | 28WEY00008P |
| 26 AWG 7/34 Overcoated Tinned Copper | | | | |
| 2 | 0.100 [2.54] | 0.200 [5.08] | 0.039 [.99] | 02WEY00007P |
| 5 | 0.400 [10.16] | 0.500 [12.70] | 0.039 [.99] | 05WEY00007P |
| 10 | 0.900 [22.86] | 1.000 [25.40] | 0.039 [.99] | 10WEY00007P |
| 15 | 1.400 [35.56] | 1.500 [38.10] | 0.039 [.99] | 15WEY00007P |
| 20 | 1.900 [48.26] | 2.000 [50.80] | 0.039 [.99] | 20WEY00007P |
| 25 | 2.400 [60.96] | 2.500 [63.50] | 0.039 [.99] | 25WEY00007P |
| 28 | 2.700 [68.58] | 2.800 [71.12] | 0.039 [.99] | 28WEY00007P |

| No. of Conductors | Dimensions | | | Part Number |
|---------------------------------------------|---------------|---------------|--------------|--------------|
| | A | B | C | |
| 24 AWG 7/32 Overcoated Tinned Copper | | | | |
| 2 | 0.100 [2.54] | 0.200 [5.08] | 0.044 [1.12] | 02WIFY00007P |
| 5 | 0.400 [10.16] | 0.500 [12.70] | 0.044 [1.12] | 05WIFY00007P |
| 10 | 0.900 [22.86] | 1.000 [25.40] | 0.044 [1.12] | 10WIFY00007P |
| 15 | 1.400 [35.56] | 1.500 [38.10] | 0.044 [1.12] | 15WIFY00007P |
| 20 | 1.900 [48.26] | 2.000 [50.80] | 0.044 [1.12] | 20WIFY00007P |
| 25 | 2.400 [60.96] | 2.500 [63.50] | 0.044 [1.12] | 25WIFY00007P |
| 28 | 2.700 [68.58] | 2.800 [71.12] | 0.044 [1.12] | 28WIFY00007P |
| 22 AWG 7/30 Tinned Copper | | | | |
| 2 | 0.100 [2.54] | 0.200 [5.08] | 0.051 [1.30] | 02WGY00001P |
| 5 | 0.400 [10.16] | 0.500 [12.70] | 0.051 [1.30] | 05WGY00006P |
| 10 | 0.900 [22.86] | 1.000 [25.40] | 0.051 [1.30] | 10WGY00002P |
| 15 | 1.400 [35.56] | 1.500 [38.10] | 0.051 [1.30] | 15WGY00006P |
| 20 | 1.900 [48.26] | 2.000 [50.80] | 0.051 [1.30] | 20WGY00006P |
| 25 | 2.400 [60.96] | 2.500 [63.50] | 0.051 [1.30] | 25WGY00006P |
| 28 | 2.700 [68.58] | 2.800 [71.12] | 0.051 [1.30] | 28WGY00006P |

Other Conductor Counts Available on Request.

Contact MADISON CABLE (1-877-MADISON), a Division of Tyco Electronics Corporation, for engineering questions or for order placement of this cable.

IDC
Ribbon Cable

.156 [3.96] Centerline, Flat Ribbon Cable, PVC Insulation

Product Specifications

Voltage Rating — 300 Volts
UL Recognized — AWM Style 2651
CSA — Available on request



| No. of Conductors | Dimensions | | | Part Number |
|----------------------------------|---------------|---------------|--------------|--------------|
| | A | B | C | |
| 22 AWG 7/30 Tinned Copper | | | | |
| 2 | 0.156 [3.96] | 0.312 [7.92] | 0.051 [1.30] | 02WGY00008P |
| 5 | 0.624 [15.85] | 0.780 [19.81] | 0.051 [1.30] | 05WGY00008P |
| 10 | 1.404 [35.66] | 1.560 [39.62] | 0.051 [1.30] | 10WGY00008P |
| 15 | 2.184 [55.47] | 2.340 [59.44] | 0.051 [1.30] | 15WGY00008P |
| 20 | 2.964 [75.29] | 3.120 [79.25] | 0.051 [1.30] | 20WGY00008P |
| 24 | 3.588 [91.14] | 3.744 [95.10] | 0.051 [1.30] | 24WGY00008P |
| 18 AWG 7/26 Tinned Copper | | | | |
| 2 | 0.156 [3.96] | 0.312 [7.92] | 0.068 [1.73] | 02WJY000001P |
| 5 | 0.624 [15.85] | 0.780 [19.81] | 0.068 [1.73] | 05WJY000010P |
| 10 | 1.404 [35.66] | 1.560 [39.62] | 0.068 [1.73] | 10WJY000010P |
| 15 | 2.184 [55.47] | 2.340 [59.44] | 0.068 [1.73] | 15WJY000010P |
| 20 | 2.964 [75.29] | 3.120 [79.25] | 0.068 [1.73] | 20WJY000010P |
| 24 | 3.588 [91.14] | 3.744 [95.10] | 0.068 [1.73] | 24WJY000010P |

Other Conductor Counts Available on Request.

Contact MADISON CABLE (1-877-MADISON), a Division of Tyco Electronics Corporation, for engineering questions or for order placement of this cable.

Prepared IDC Ribbon Cable



In addition to bulk cable, the US Engineering Cable Assembly Group offers Prepared Cable for the .100 [2.54] and .156 [3.96] centerline cables. This can be in the form of prenotched cable on reels or cut-to-length cable segments.

Prenotched 250 foot reels of cable can be produced with notches at varying increments or repeating all along the cable. The maximum width of these cables

is 20 conductor for the .100 [2.54] centerline and 13 conductor for the .156 [3.96] centerline.

Prepared Cable is also available with a Strip and Retain feature allowing the cable assembly to be soldered directly to the PC Board. This saves space and cost and reduces spare parts inventory. Strip and Retain on both ends is used in family board applications to maintain the

electrical connection when the PC Board is separated into smaller boards after soldering. Widths are limited to 20 conductors for the .100 [2.54] centerline and 13 conductors for the .156 [3.96] centerline. However, multiple cables can be placed side-by-side in a single connector. For other styles and configurations contact the product engineer or product manager.



MTA Wire Termination Flowchart

Choose the appropriate MTA Connector from the MTA Catalog 82056.

Select the proper wire style and AWG for the chosen MTA Connector
(Refer to pages 70-74).

Choose the MTA Termination Tooling (Refer to pages 76-79).

Terminate the Wire-to-MTA Connector per Application Tooling Instruction Sheet.

Inspect the MTA Wire Termination per Application Specification, especially the wire depth. See illustrations: 114-13072 — MTA-50 Connectors, 114-1019 — MTA-100 Connectors, 114-1020 — MTA-156 Connectors, Posted Connector, Card Edge, 114-1048 — MTA-156 Quad Connectors, 114-1031 — MTA-100 Ribbon Cable Connector Assembly, and 114-1032 — MTA-156 Ribbon Cable Connector Assembly.



| Connector | A | B |
|-----------|--------------------------|----------------|
| MTA-100 | .069-.087 [1.75-2.21] | .040 [1.02] |
| MTA-156 | .090-.113 [2.29-2.87] | .060 [1.52] |

Adjust the Termination Tooling (if needed) per Tooling Instruction Sheet
(repeat the step above).

MTA Application Tooling Options

One-At-A-Time Termination Tooling Part Numbers

Note: Max. Insulation Outside Diameter Wire:
.060 [1.52] for MTA-100 Connectors/.095 [2.41] for MTA-156 Connectors

| MTA Connector Assembly | Interchangeable Head | | Interchangeable Head and Loose-Piece Feed Track | Interchangeable Head and Tape Feed Track | Special Applicator | T-Handle Maintenance Tool | Notes: |
|------------------------|----------------------------------------------------------------------------------------------------------------------|---------------------------------------------------------------------|-------------------------------------------------|------------------------------------------|--------------------|---------------------------|------------------------------------------------------------------------------------------------------------------------------------------------------------------------------------------------------------------------------------------------------------------------------------------------------------------------------------------------------------------------------------------------------------------------------------------------------------------------------------------------------------------------------------------------------------------------------------------------------------------------------------------------------------------------------------------------------------------------------------------------------------------------------------------------------------------------------------------------------------------------------------------------------------|
| | Manual Hand Tool 58074-1 Air Hand Tool 58075-1 Air Bench Mount Tool 58338-1 Electric Bench Machine 931800-1 | Part Number | | | | | |
| MTA-50 | Closed End | 1583503-1 | — | — | — | — | <ol style="list-style-type: none"> A repair kit consists of a cam, a feed-slide sub-assembly and a locating pawl. Repair kits can be made available for other interchangeable heads. Consult Tyco Electronics. Standard modular heads 58246-1 and 58247-1 are recommended for low volume use. Extended wear modular heads 58246-2 and 58247-2 are recommended for high volume use. T-Handle Maintenance Tools are for maintenance (field) use only. They are not recommended for production. Some Manual Hand Tool Assemblies are available: <ol style="list-style-type: none"> Order 58579-1, comprised of Head 58246-1 with Manual Hand Tool 58074-1. Order 58580-1, comprised of Head 58247-1 with Manual Hand Tool 58074-1. Order 58639-1, comprised of Head 58638-1 with Manual Hand Tool 58074-1. |
| | Feed Thru | 58246-1 (Standard)* 58246-2 (Ext Wear) 58246-3 (Ribbon Cable) | — | — | — | — | |
| MTA-100 Connector | Closed End | 933567-1 | 853546-1 & 853542-1 (Base) | 466728-1 | 59803-1 | | |
| | Feed Thru | 58442-1 | — | — | 59803-1 | | |
| | Posted (Closed-End) | 58638-1 | — | — | 59803-1 | | |
| MTA-156 Connector | Closed End | 933568-1 | 853547-1 & 853542-1 (Base) | 466727-1 | 59804-1 | | |
| | Feed Thru | 58443-1 | — | — | 59804-1 | | |
| | Posted (Closed-End) | 58082-1 | — | — | 59804-1 | | |
| | Card-Edge | 58061-1 | — | — | 567020-1 | | |
| MTA-156 Quad | Closed End | 58392-1 | — | — | 59804-1 | | |

*Repair Kit 856600-1 **Repair Kit 856600-2

MTA-50 Mass Termination Tooling Part Numbers

Manual Arbor Frame (with slide) Part Number 1583518-1*
Upper Tooling Part Number 1583514-1*
Fixture, Discrete Wire, Closed End Part Number 1583515-1 (28-26 AWG)
Part Number 1583515-2 (30-28 AWG)
Fixture, Discrete Wire, Feed-Thru Part Number 1583516-1 (28-26 AWG)
Part Number 1583516-2 (30-28 AWG)
Fixture, Ribbon Cable, Closed End or Feed-Thru Part Number 1583517-1
*Required, plus appropriate Fixture(s).

MTA-100 and MTA-156 Mass Termination Tooling Part Numbers

Note: Max. Insulation Outside Diameter Wire:
.050 [1.27] for MTA-100 Connectors/.070 [1.78] for MTA-156 Connectors

| MTA Connector Assembly | Interchangeable Head | | Harness Board Holding Fixture | | | Interchangeable Head and Tape Feed Track | |
|------------------------|----------------------|--------------------------------------------------------------------------------|-------------------------------|---------------------|----------------------------------|----------------------------------------------------|-----------|
| | Part Number | Used With | Part Number | Applicator Assembly | Tooling Assembly | Part Number | Used With |
| MTA-100 Connector | Closed End | — | 58242-1 | — | — | 854175-1 & 854200-1 (Base) | 312522-1 |
| | Feed Thru | 58644-1 (Discrete Wire) [†] 58644-2 (Notched Cable) [†] | 58074-1 (Man Hd TI) | 58243-1 | 58575-1 | — | — |
| | Closed End (Posted) | — | — | 58635-1 | 58575-1 | — | — |
| | Feed Thru (Posted) | — | — | 58636-1 | 58575-1 | — | — |
| MTA-156 Connector | Closed End | — | — | 58244-1 | — | 854176-1 & 854200-1 (Base) | 312522-1 |
| | Feed Thru | 58646-1 (Discrete Wire) ^{††} 58646-2 (Notched Cable) ^{††} | 58074-1 (Man Hd TI) | 58245-1 | — | — | — |
| | Card Edge | — | — | 58245-3 | 58576-1 | — | — |
| | Closed End (Posted) | — | — | 59848-1 | — | — | — |
| | Feed Thru (Posted) | — | — | 59848-3 | 58576-1 | — | — |
| | Card Edge | — | — | 58009-1 | — | — | — |
| MTA-156 Quad | Closed End | — | — | 58009-2 | 58576-1 | — | — |
| | Feed Thru | — | — | 58010-2 | 58576-1 | — | — |
| | Closed End | — | — | 58244-1 | — | Manual Bench Tool 58024-1 and Tooling Assy 58040-1 | — |
| Feed Thru | — | — | 58244-3 | 58576-1 | — | — | |
| Card Edge | — | — | 58245-1 | — | 58024-1 and Tooling Assy 58040-1 | — | |
| Card Edge | — | — | 58245-3 | 58576-1 | — | — | |

[†]2- through 12-positions. ^{††}2- through 8-positions.

MTA Application Tooling Options (Continued)

**One-At-A-Time Termination
Tooling (Typical Tooling
Combinations)**



Manual Hand Tool with
Interchangeable Head



Air Hand Tool with
Interchangeable Head



Air Bench Mount Tool with
Interchangeable Head and
Foot Switch



Electric Bench Machine with
Interchangeable Head

Power Units

**Manual Hand Tool —
Pistol Grip Handle
Part No. 58074-1**

- Easy to use
- Ratchet control will not release the trigger until it is fully bottomed
- Head may be rotated for user convenience

**Air Hand Tool —
Pistol Grip Pneumatic Handle
Part No. 58075-1**

- Light weight
- Operates at air pressure between 40 and 70 psi [2.76 and 4.83 bar]
- Head may be rotated for user convenience

**Air Bench Mount Tool —
Bench Mount Power Assembly
Part No. 58338-1**

- May be mounted with interchangeable head pointed up or down
- Operated by a foot switch
- Operates at air pressure between 40 and 70 psi [2.76 and 4.83 bar]

**Electric Bench Machine —
IDC Power Unit
Part No. 931800-1**

- All electric: 120 VAC, 60 Hz, 2 A
- Compact, portable and quiet
- Operated by a foot switch



Air Bench Mount Tool with
Interchangeable Head and Loose-Piece Feed Track



Electric Bench Machine with
Interchangeable Head and
Tape Feed Track



AMP-O-LECTRIC Bench
Machine with Special Applicator

Interchangeable Heads and Applicators (Refer to page 76 for part numbers.)

Interchangeable Head

- Terminates one unstripped wire per cycle
- Aligns and holds the connector in place for each termination
- Automatically advances the connector after each termination



**Interchangeable Head and
Loose-Piece Feed Track**

- No special setup required
- Connectors are easily loaded into feed track
- Connectors are fed using a simple spring-loaded pusher

T-Handle Maintenance Tool

**Interchangeable Head and
Tape Feed Track**

- No special setup required
- Tape-mounted connectors are transferred from product reel to feed track by simply pulling on the free end of the carrier tape
- Connectors are fed using a simple spring-loaded pusher

Special Applicator

- Connectors are easily hand loaded into feed track
- Automatically advances the connector after each termination
- Cannot be cycled until the connector is properly positioned

MTA Application Tooling Options (Continued)

**Mass Termination Tooling
(Typical Tooling
Combinations)**



Manual Bench Tool with
Applicator and Holding Fixture



Air Harness Tool with
Applicator



Air Bench Machine



2700 lb Air Bench Machine with
Ribbon Cable Notcher Assembly

Power Units

**Manual Bench Tool —
Arbor Frame Assembly
Part No. 58024-1**

- Applicator and holding fixture can be oriented for operator convenience for closed-end or feed-thru terminations
- Ram height (insertion depth) is easily adjusted
- May be bench mounted

**Air Harness Tools —
Hand-Held Power Unit
with Applicator
Part No. 58575-1 (MTA-100)
Part No. 58576-1 (MTA-156)**

- Applicator can be rotated 360° for orientation with holding fixture
- Insertion depth is easily adjusted
- Operates at air pressure between 75 and 95 psi [5.17 and 6.55 bar]

**Air Bench Machine —
Pneumatic Unit
Part No. 91112-2**

- Operated by a foot switch
- Operates at air pressure between 80 and 90 psi [5.52 and 6.21 bar]
- Not recommended for notching cable with more than 14 conductors

**2700 lb Air Bench Machine —
Part No. 312522-1**

- Operated by a foot switch
- Capable of exerting 2,700 lb [12,000 N] of force at minimum 80 psi [5.52 bar] air pressure
- May be bench mounted

Applicators and Notcher Assemblies



Manual Bench Tool with Applicator and Tape Feed Track

Applicator and Holding Fixture

- Wires are laced into plastic combs for mass termination
- Trims excess wire for closed-end terminations
- Holding fixture may be mounted to a harness board

Applicator and Tape Feed Track

- Tape-mounted connectors are transferred from product reel to feed track by simply pulling on the free end of the carrier tape
- Connectors are fed using a simple spring-loaded pusher
- Feed stop easily adjusted for different connector sizes

Ribbon Cable Notcher Assembly

- Notch cable with up to 28 conductors for .100 centerline, and 24 conductors for .156 centerline
- Pressure plate holds cable in position during notching
- Scrap conveniently removed through a chute with a blast of air from a built-in air valve



Ribbon Cable Notcher
Assembly

| Part Number | Wire Size AWG | Centerline | Used With |
|-------------|---------------|--------------|------------------------------------------------------------------------------------------------------------------|
| 854449-2 | 26-28 | .100 2.54 | Manual Bench Tool 58024-1 |
| 854449-4 | 22-28 | .100 2.54 | Air Bench Machine 91112-2 |
| 854449-3 | 18-24 | .156 3.96 | 2700 lb Bench Machine 312522-1 AMP-O-LECTRIC Bench Machine 1-471273-3 (with Conversion Kit 690675-2) |

Use Adapter 854468-1 when putting Notcher in the AMP-O-LECTRIC Machine. Use Adapter 854468-2 when putting Notcher in the 2700 lb Air Bench Machine.

MTA Application Tooling Options (Continued)

Technical Documents

The following is a list of technical documents covering the installation, operation, adjustment, maintenance and repair of MTA application tooling.

Instruction Sheets (IS) provide instructions for assembling or applying the product. They are intended for the Manufacturing Assembler or Operator.

Customer Manuals (CM) provide complete, detailed instructions on the installation, operation, adjustment, maintenance and repair of complex tools and application machines.

Applicator Instructions (AI) are similar to instruction sheets (which cover products and tools), and provide instructions for installation, adjustment and maintenance of applicators used in automatic and semiautomatic machines.

Hand Tools, Power Units & Accessories

| | | | | | |
|-------------------------------------|-----------|-------------|-------------------------------|------------|-------------|
| Manual Arbor Frame (MTA-50) | 1583518-1 | IS 408-8812 | 2700 lb Air Bench Machine | 312522-1 | CM 409-5843 |
| Upper Tooling (MTA-50) | 1583514-1 | IS 408-8812 | Terminator Assembly, "G" Term | 354500-1 | CM 409-5842 |
| Manual Arbor Frame Assembly | 58024-1 | IS 408-6923 | AMP-O-LECTRIC Bench Machine | 1-471273-3 | CM 409-5128 |
| Ribbon Cable Applicator, .100 | 58039-1 | IS 408-6685 | Conversion Kit | 690675-2 | IS 408-8022 |
| Ribbon Cable Applicator, .156 | 58040-1 | IS 408-6701 | Base Assembly | 853542-1 | IS 408-9636 |
| Manual Hand Tool | 58074-1 | IS 408-6790 | Base | 854200-1 | IS 408-9650 |
| Air Bench Mount Tool | 58338-1 | IS 408-9393 | Adapter (AMP-O-LECTRIC) | 854468-1 | IS 408-9687 |
| Air Hand Tool (MTA-100) | 58575-1 | IS 408-4260 | Adapter (2700 lb Machine) | 854468-2 | IS 408-9687 |
| Air Harness Tool (MTA-156) | 58576-1 | IS 408-4260 | Repair Kit | 856600-1 | IS 408-9745 |
| T-Handle Maintenance Tool (MTA-100) | 59803-1 | IS 408-7907 | Repair Kit | 856600-2 | IS 408-9745 |
| T-Handle Maintenance Tool (MTA-156) | 59804-1 | IS 408-7907 | Electric Bench Mount Tool | 931800-1 | CM 409-5746 |
| Air Arbor Frame Assembly | 91112-2 | IS 408-7763 | | | |

One-At-A-Time Termination Tooling

Interchangeable Heads

| MTA-50 | | MTA-156 | |
|-----------|-------------|---------|-------------|
| 1583503-1 | IS 408-8801 | 58247-1 | IS 408-6930 |
| | | 58247-2 | IS 408-9380 |
| MTA-100 | | 58247-3 | IS 408-4146 |
| 58246-1 | IS 408-6929 | 58443-1 | IS 408-9607 |
| 58246-2 | IS 408-9379 | 58061-1 | IS 408-6794 |
| 58246-3 | IS 408-4147 | 58082-1 | IS 408-6795 |
| 58442-1 | IS 408-9603 | 58392-1 | IS 408-9450 |
| 58638-1 | IS 408-4358 | | |

Interchangeable Head & Loose Piece Feed Track

| MTA-100 | | MTA-156 | |
|----------|-------------|----------|-------------|
| 933567-1 | IS 408-9435 | 933568-1 | IS 408-9466 |

Interchangeable Heads & Tape Feed Track

| MTA-100 | | MTA-156 | |
|----------|-------------|----------|-------------|
| 853546-1 | IS 408-9636 | 853547-1 | IS 408-9637 |

Special Applicators

| MTA-100 | | MTA-156 | |
|----------|-------------|----------|-------------|
| 466728-1 | AI 408-8054 | 466727-1 | AI 408-8054 |
| | | 567020-1 | AI 408-8069 |

Mass Termination Tooling

| MTA-50 | | MTA-100 | | MTA-156 | | Die Set Assembly | |
|-----------|-------------|---------|-------------|---------|-------------|------------------|-------------|
| 1583515-1 | IS 408-8812 | 58242-1 | IS 408-7994 | 58009-1 | IS 408-7995 | 854175-1 | IS 408-9667 |
| 1583515-2 | IS 408-8812 | 58242-3 | IS 408-7994 | 58009-2 | IS 408-7995 | | |
| 1583516-1 | IS 408-8812 | 58243-1 | IS 408-7994 | 58010-2 | IS 408-7995 | | |
| 1583516-2 | IS 408-8812 | 58635-1 | IS 408-7994 | 58244-1 | IS 408-7995 | 854176-1 | IS 408-9650 |
| 1583517-1 | IS 408-8812 | 58636-1 | IS 408-7994 | 58244-3 | IS 408-7995 | | |
| | | 58644-1 | IS 408-4406 | 58245-1 | IS 408-7995 | | |
| | | 58644-2 | IS 408-4440 | 58245-3 | IS 408-7995 | | |
| | | 59844-1 | IS 408-7994 | 58646-1 | IS 408-4405 | | |
| | | 59845-1 | IS 408-7994 | 58646-2 | IS 408-4439 | | |
| | | 59845-3 | IS 408-7994 | 59848-1 | IS 408-7995 | | |
| | | | | 59848-3 | IS 408-7995 | | |

Typical Application Rates

Produce 6-in. [15 cm] Long Jumpers, One 4-Position MTA-100 Connector per End, Discrete Wire

| Method | Terminations Per Hour |
|------------------------------------------------------------------------------------------------------------|-----------------------|
| Manual Hand Tool 58074-1 with Interchangeable Head 58246-1 | — |
| Electric Bench Machine 931800-1 with Interchangeable Head 58246-1 | 900 |
| Electric Bench Machine 931800-1 with Interchangeable Head and Loose-Piece Feed Track 933567-1 | 1,100 |
| Electric Bench Machine 931800-1 with Interchangeable Head and Tape Feed Track 853546-1 and 853542-1 (Base) | 1,250 |

Apply One 4-Position MTA-100 Feed-Thru Connector per Assembly, Discrete Wire

| Method | Terminations Per Hour |
|---------------------------------------------------------------|-----------------------|
| Manual Bench Tool 58024-1 with Applicator and Holding Fixture | 650 |

For further information about tooling call Technical Support.

Produce 6-in. [15 cm] Long Jumpers, One 4-Position MTA-100 Connector per End, Ribbon Cable*

| Method | Terminations Per Hour |
|-----------------------------------------------------------------------------------------------------|-----------------------|
| 2700 lb Air Bench Machine 312522-1 with Applicator and Tape Feed Track 854175-1 and 854200-1 (Base) | 7,500 |

* Procedure: Mass terminate 12-conductor ribbon cable with three connectors per end. After terminating, separate by tearing the 12-conductor assembly into three 4-conductor assemblies.

Cable Notching

| Method | Cable Ends Per Hour |
|-------------------------------------------------------------------------------------------------------|---------------------|
| 2700 lb Air Bench Machine 312522-1 with Ribbon Cable Notcher Assembly 854449-2 and 854468-2 (Adapter) | 1,000 |

Part Number Index

Note: This index lists all cataloged parts by base no. only. Complete part nos. (with prefixes and/or suffixes) are shown on the page(s) indicated.

| Part No. | Page |
|--------------|--------|
| 02WEY00007P | 72 |
| 02WEY00008P | 72 |
| 02WFY00006P | 72 |
| 02WFY00007P | 72 |
| 02WGY00001P | 72 |
| 02WGY00008P | 73 |
| 02WJY000001P | 73 |
| 05WEY00004P | 72 |
| 05WEY00007P | 72 |
| 05WFY00006P | 72 |
| 05WFY00007P | 72 |
| 05WGY00006P | 72 |
| 05WGY00008P | 73 |
| 05WJY000010P | 73 |
| 10WEY00007P | 72 |
| 10WEY00012P | 72 |
| 10WFY00006P | 72 |
| 10WFY00007P | 72 |
| 10WGY00002P | 72 |
| 10WGY00008P | 73 |
| 10WJY000010P | 73 |
| 15WEY00002P | 72 |
| 15WEY00007P | 72 |
| 15WFY00006P | 72 |
| 15WFY00007P | 72 |
| 15WGY00006P | 72 |
| 15WGY00008P | 73 |
| 15WJY000010P | 73 |
| 20WEY00007P | 72 |
| 20WEY00008P | 72 |
| 20WFY00006P | 72 |
| 20WFY00007P | 72 |
| 20WGY00006P | 72 |
| 20WGY00008P | 73 |
| 20WJY000010P | 73 |
| 24WGY00008P | 73 |
| 24WJY000010P | 73 |
| 25WEY00007P | 72 |
| 25WEY00008P | 72 |
| 25WFY00006P | 72 |
| 25WFY00007P | 72 |
| 25WGY00006P | 72 |
| 28WEY00007P | 72 |
| 28WEY00008P | 72 |
| 28WFY00006P | 72 |
| 28WFY00007P | 72 |
| 28WGY00006P | 72 |
| 57034 | 71 |
| 57040 | 71 |
| 350980 | 59, 60 |
| 640250 | 60 |
| 640251 | 60 |
| 640252 | 59, 60 |
| 640383 | 46 |
| 640384 | 46 |
| 640385 | 47 |
| 640387 | 49 |
| 640388 | 48 |

| Part No. | Page |
|----------|------|
| 640389 | 49 |
| 640426 | 37 |
| 640427 | 37 |
| 640428 | 37 |
| 640429 | 37 |
| 640430 | 37 |
| 640431 | 37 |
| 640432 | 37 |
| 640433 | 37 |
| 640434 | 37 |
| 640435 | 37 |
| 640440 | 15 |
| 640441 | 15 |
| 640442 | 15 |
| 640443 | 15 |
| 640445 | 48 |
| 640452 | 21 |
| 640453 | 21 |
| 640454 | 23 |
| 640455 | 23 |
| 640456 | 24 |
| 640457 | 24 |
| 640468 | 15 |
| 640469 | 15 |
| 640470 | 15 |
| 640471 | 15 |
| 640472 | 37 |
| 640473 | 37 |
| 640474 | 37 |
| 640475 | 37 |
| 640476 | 37 |
| 640477 | 37 |
| 640478 | 37 |
| 640479 | 37 |
| 640480 | 37 |
| 640481 | 37 |
| 640550 | 16 |
| 640551 | 40 |
| 640556 | 41 |
| 640557 | 41 |
| 640558 | 41 |
| 640559 | 41 |
| 640595 | 39 |
| 640599 | 39 |
| 640600 | 39 |
| 640601 | 39 |
| 640602 | 39 |
| 640604 | 39 |
| 640605 | 39 |
| 640606 | 39 |
| 640607 | 39 |
| 640608 | 39 |
| 640620 | 15 |
| 640621 | 15 |
| 640622 | 15 |
| 640623 | 15 |
| 640629 | 42 |
| 640630 | 42 |
| 640631 | 41 |
| 640632 | 41 |
| 640633 | 41 |
| 640634 | 41 |

| Part No. | Page |
|----------|------|
| 640635 | 41 |
| 640636 | 17 |
| 640637 | 17 |
| 640638 | 17 |
| 640639 | 17 |
| 640642 | 16 |
| 640643 | 40 |
| 640706 | 59 |
| 640707 | 59 |
| 640708 | 17 |
| 640709 | 17 |
| 640859 | 56 |
| 640860 | 56 |
| 640861 | 56 |
| 640862 | 56 |
| 640863 | 56 |
| 640864 | 56 |
| 640865 | 56 |
| 640866 | 56 |
| 640867 | 56 |
| 640868 | 56 |
| 641101 | 57 |
| 641106 | 57 |
| 641113 | 46 |
| 641114 | 46 |
| 641115 | 47 |
| 641118 | 49 |
| 641119 | 48 |
| 641120 | 48 |
| 641121 | 49 |
| 641122 | 21 |
| 641123 | 21 |
| 641124 | 23 |
| 641125 | 23 |
| 641126 | 24 |
| 641127 | 24 |
| 641143 | 41 |
| 641144 | 41 |
| 641145 | 41 |
| 641146 | 41 |
| 641147 | 41 |
| 641148 | 37 |
| 641149 | 37 |
| 641150 | 37 |
| 641151 | 37 |
| 641152 | 37 |
| 641153 | 37 |
| 641154 | 37 |
| 641155 | 37 |
| 641156 | 37 |
| 641157 | 37 |
| 641168 | 39 |
| 641169 | 39 |
| 641170 | 39 |
| 641171 | 39 |
| 641172 | 39 |
| 641173 | 39 |
| 641174 | 39 |
| 641175 | 39 |
| 641176 | 39 |
| 641177 | 39 |
| 641186 | 17 |

| Part No. | Page |
|----------|------|
| 641187 | 17 |
| 641188 | 17 |
| 641189 | 17 |
| 641190 | 15 |
| 641191 | 15 |
| 641192 | 15 |
| 641193 | 15 |
| 641198 | 15 |
| 641199 | 15 |
| 641200 | 15 |
| 641201 | 15 |
| 641202 | 46 |
| 641203 | 46 |
| 641204 | 47 |
| 641207 | 49 |
| 641208 | 48 |
| 641209 | 48 |
| 641210 | 49 |
| 641211 | 21 |
| 641212 | 21 |
| 641213 | 23 |
| 641214 | 23 |
| 641215 | 24 |
| 641216 | 24 |
| 641217 | 37 |
| 641218 | 37 |
| 641219 | 37 |
| 641220 | 37 |
| 641221 | 37 |
| 641222 | 37 |
| 641223 | 37 |
| 641224 | 37 |
| 641225 | 37 |
| 641226 | 37 |
| 641227 | 39 |
| 641228 | 39 |
| 641229 | 39 |
| 641230 | 39 |
| 641231 | 39 |
| 641232 | 39 |
| 641233 | 39 |
| 641234 | 39 |
| 641235 | 39 |
| 641236 | 39 |
| 641237 | 15 |
| 641238 | 15 |
| 641239 | 15 |
| 641240 | 15 |
| 641241 | 15 |
| 641242 | 15 |
| 641243 | 15 |
| 641244 | 15 |
| 641283 | 56 |
| 641284 | 56 |
| 641285 | 56 |
| 641286 | 56 |
| 641287 | 56 |
| 641288 | 56 |
| 641289 | 56 |
| 641290 | 56 |
| 641291 | 56 |
| 641292 | 56 |

Part Number Index (Continued)

| Part No. | Page | Part No. | Page | Part No. | Page | Part No. | Page |
|----------|------|----------|------|----------|------|----------|------|
| 641293 | 57 | 643995 | 45 | 644574 | 15 | 644876 | 23 |
| 641301 | 39 | 644020 | 15 | 644575 | 15 | 644877 | 23 |
| 641302 | 39 | 644038 | 15 | 644576 | 15 | 644878 | 37 |
| 641303 | 39 | 644040 | 15 | 644577 | 15 | 644884 | 22 |
| 641304 | 39 | 644042 | 15 | 644578 | 15 | 644885 | 22 |
| 641305 | 39 | 644043 | 15 | 644579 | 15 | 644886 | 22 |
| 641306 | 39 | 644044 | 15 | 644611 | 50 | 644887 | 22 |
| 641307 | 39 | 644082 | 37 | 644612 | 50 | 644888 | 22 |
| 641308 | 39 | 644083 | 15 | 644613 | 51 | 644889 | 22 |
| 641309 | 39 | 644284 | 37 | 644614 | 51 | 644890 | 22 |
| 641310 | 39 | 644312 | 15 | 644615 | 50 | 644891 | 22 |
| 641311 | 15 | 644313 | 15 | 644616 | 50 | 644892 | 32 |
| 641312 | 15 | 644329 | 55 | 644617 | 51 | 644893 | 32 |
| 641313 | 15 | 644370 | 55 | 644627 | 50 | 644894 | 32 |
| 641314 | 15 | 644371 | 55 | 644628 | 50 | 644896 | 32 |
| 641425 | 45 | 644375 | 55 | 644629 | 51 | 644897 | 32 |
| 641426 | 45 | 644376 | 55 | 644630 | 51 | 644898 | 32 |
| 641427 | 45 | 644377 | 55 | 644631 | 50 | 647000 | 20 |
| 641428 | 45 | 644381 | 55 | 644632 | 50 | 647001 | 20 |
| 641429 | 45 | 644382 | 55 | 644633 | 51 | 647002 | 20 |
| 641435 | 45 | 644383 | 55 | 644662 | 37 | 647003 | 20 |
| 641436 | 45 | 644387 | 55 | 644663 | 37 | 647004 | 20 |
| 641437 | 45 | 644388 | 55 | 644687 | 37 | 647005 | 20 |
| 641438 | 45 | 644389 | 55 | 644694 | 22 | 647006 | 20 |
| 641439 | 45 | 644456 | 22 | 644695 | 22 | 647007 | 20 |
| 641440 | 42 | 644457 | 22 | 644702 | 15 | 647008 | 20 |
| 641522 | 45 | 644460 | 37 | 644718 | 39 | 647009 | 20 |
| 641523 | 45 | 644461 | 37 | 644720 | 39 | 647010 | 20 |
| 641524 | 45 | 644462 | 37 | 644726 | 15 | 647011 | 20 |
| 641525 | 45 | 644463 | 37 | 644749 | 46 | 647012 | 20 |
| 641526 | 45 | 644464 | 37 | 644750 | 46 | 647013 | 20 |
| 641533 | 42 | 644465 | 39 | 644751 | 47 | 647014 | 20 |
| 641534 | 15 | 644466 | 39 | 644752 | 48 | 647015 | 20 |
| 641535 | 15 | 644467 | 39 | 644753 | 48 | 647016 | 20 |
| 641536 | 15 | 644468 | 39 | 644754 | 49 | 647017 | 20 |
| 641537 | 15 | 644469 | 39 | 644755 | 49 | 647018 | 20 |
| 641550 | 59 | 644470 | 39 | 644756 | 46 | 647019 | 20 |
| 641623 | 42 | 644471 | 39 | 644757 | 46 | 647020 | 20 |
| 641643 | 17 | 644472 | 39 | 644758 | 47 | 647021 | 20 |
| 641644 | 17 | 644486 | 30 | 644759 | 48 | 647022 | 20 |
| 641645 | 17 | 644487 | 30 | 644760 | 48 | 647023 | 20 |
| 641646 | 17 | 644488 | 30 | 644761 | 49 | 647030 | 20 |
| 641653 | 15 | 644489 | 30 | 644762 | 49 | 647031 | 20 |
| 641654 | 15 | 644497 | 15 | 644763 | 46 | 647032 | 20 |
| 641655 | 15 | 644501 | 37 | 644764 | 46 | 647033 | 20 |
| 641656 | 15 | 644502 | 37 | 644765 | 47 | 647047 | 27 |
| 641994 | 17 | 644508 | 55 | 644766 | 48 | 647048 | 27 |
| 643067 | 40 | 644509 | 55 | 644767 | 48 | 647050 | 28 |
| 643071 | 40 | 644510 | 55 | 644768 | 49 | 647051 | 28 |
| 643075 | 16 | 644511 | 15 | 644769 | 49 | 647075 | 27 |
| 643077 | 16 | 644512 | 15 | 644783 | 37 | 647076 | 27 |
| 643498 | 15 | 644513 | 15 | 644791 | 37 | 647078 | 28 |
| 643813 | 15 | 644514 | 15 | 644795 | 15 | 647079 | 28 |
| 643814 | 15 | 644540 | 15 | 644803 | 30 | 647106 | 29 |
| 643815 | 15 | 644563 | 15 | 644807 | 45 | 647107 | 29 |
| 643816 | 15 | 644564 | 15 | 644809 | 45 | 647108 | 29 |
| 643817 | 37 | 644565 | 15 | 644812 | 45 | 647109 | 27 |
| 643818 | 37 | 644566 | 37 | 644814 | 45 | 647114 | 27 |
| 643819 | 37 | 644567 | 39 | 644860 | 37 | 647116 | 28 |
| 643820 | 37 | 644569 | 39 | 644861 | 30 | 647117 | 28 |
| 643821 | 37 | 644570 | 39 | 644874 | 24 | 647123 | 53 |
| 643828 | 15 | 644572 | 39 | 644875 | 24 | 647124 | 53 |

Part Number Index (Continued)

| Part No. | Page | Part No. | Page | Part No. | Page | Part No. | Page |
|----------|------|----------|--------|----------|------|----------|------|
| 647125 | 53 | 647478 | 37 | 1123723 | 65 | 1445351 | 7 |
| 647126 | 53 | 647479 | 39 | 1123724 | 68 | 1445352 | 7 |
| 647127 | 53 | 647480 | 15 | 1123823 | 69 | 1445353 | 7 |
| 647128 | 53 | 647481 | 45 | 1123824 | 69 | 1445354 | 7 |
| 647131 | 53 | 647485 | 62 | 1318300 | 65 | 1445355 | 7 |
| 647132 | 53 | 647496 | 39 | 1318301 | 68 | 1445356 | 7 |
| 647133 | 53 | 647497 | 45 | 1318831 | 69 | 1445357 | 7 |
| 647134 | 53 | 647609 | 25 | 1318912 | 64 | 1445358 | 7 |
| 647135 | 53 | 647623 | 25 | 1375819 | 31 | 1445359 | 5 |
| 647136 | 53 | 647624 | 25 | 1375820 | 31 | 1445360 | 5 |
| 647139 | 53 | 647625 | 25 | 1445120 | 9 | 1445361 | 5 |
| 647140 | 53 | 647626 | 25 | 1445121 | 10 | 1445362 | 5 |
| 647141 | 53 | 647627 | 25 | 1445123 | 9 | 1445363 | 5 |
| 647142 | 53 | 647628 | 26 | 1445124 | 10 | 1445364 | 5 |
| 647143 | 53 | 647629 | 26 | 1445125 | 9 | 1445365 | 5 |
| 647144 | 53 | 647630 | 26 | 1445126 | 10 | 1445366 | 5 |
| 647166 | 29 | 647646 | 47 | 1445169 | 9 | 1445367 | 5 |
| 647167 | 29 | 647648 | 52 | 1445170 | 9 | 1445368 | 5 |
| 647168 | 29 | 647649 | 52 | 1445171 | 9 | 1445369 | 5 |
| 647295 | 28 | 647651 | 26 | 1445172 | 10 | 1445370 | 5 |
| 647296 | 28 | 647652 | 26 | 1445173 | 10 | 1445371 | 5 |
| 647297 | 28 | 647653 | 26 | 1445174 | 10 | 1445372 | 5 |
| 647298 | 27 | 647676 | 65 | 1445336 | 31 | 1445373 | 5 |
| 647299 | 27 | 647689 | 65 | 1445341 | 7 | 1445374 | 5 |
| 647300 | 27 | 647690 | 64 | 1445342 | 7 | 1445375 | 5 |
| 647400 | 62 | 770258 | 59 | 1445343 | 7 | 1445376 | 5 |
| 647401 | 62 | 770476 | 59, 60 | 1445344 | 7 | 1744017 | 48 |
| 647402 | 62 | 770522 | 59 | 1445345 | 7 | 1744020 | 15 |
| 647406 | 62 | 770849 | 60 | 1445346 | 7 | 1744036 | 67 |
| 647409 | 62 | 770894 | 61 | 1445347 | 7 | 1744037 | 67 |
| 647466 | 62 | 971111 | 71 | 1445348 | 7 | 1744048 | 67 |
| 647476 | 45 | 1123721 | 64 | 1445349 | 7 | 1744055 | 66 |
| 647477 | 15 | 1123722 | 64 | 1445350 | 7 | 1744056 | 66 |

Application Tooling Part Number Index

| Part No. | Page | Part No. | Page | Part No. | Page | Part No. | Page |
|----------|------------|----------|------------|----------|------------|----------|------------|
| 58009 | 76, 79 | 58517 | 31 | 91112 | 78, 79 | 853547 | 76, 79 |
| 58010 | 76, 79 | 58575 | 76, 78, 79 | 91579 | 64 | 854175 | 76, 79 |
| 58024 | 76, 78, 79 | 58576 | 76, 78, 79 | 312522 | 76, 78, 79 | 854176 | 76, 79 |
| 58039 | 76, 79 | 58579 | 76 | 354500 | 79 | 854200 | 76, 79 |
| 58040 | 76, 79 | 58614 | 59 | 466468 | 59 | 854449 | 78 |
| 58061 | 76, 79 | 58635 | 76, 79 | 466727 | 76, 79 | 854468 | 78, 79 |
| 58074 | 76, 77, 79 | 58636 | 76, 79 | 466728 | 76, 79 | 856600 | 76, 79 |
| 58075 | 76, 77 | 58638 | 76, 79 | 466747 | 17 | 931800 | 76, 77, 79 |
| 58082 | 76, 79 | 58639 | 76 | 466947 | 59 | 933567 | 76, 79 |
| 58242 | 76, 79 | 58644 | 76, 79 | 471273 | 78, 79 | 933568 | 76, 79 |
| 58243 | 76, 79 | 58646 | 76, 79 | 567020 | 76, 79 | 1385286 | 64 |
| 58244 | 76, 79 | 59803 | 76, 79 | 567373 | 31 | 1583503 | 76, 79 |
| 58245 | 76, 79 | 59804 | 76, 79 | 567827 | 31 | 1583514 | 76, 79 |
| 58246 | 76, 79 | 59836 | 17 | 567828 | 59 | 1583515 | 76, 79 |
| 58247 | 76, 79 | 59837 | 41 | 567910 | 31 | 1583516 | 76, 79 |
| 58338 | 76, 77, 79 | 59839 | 76 | 680211 | 59 | 1583517 | 76, 79 |
| 58392 | 76, 79 | 59845 | 79 | 690675 | 78, 79 | 1583518 | 76, 79 |
| 58442 | 76, 79 | 59848 | 76, 79 | 853542 | 76, 79 | | |
| 58443 | 76, 79 | 90471 | 59 | 853546 | 76, 79 | | |

Americas

Argentina – Buenos Aires
Phone: +54-11-4733-2200
Fax: +54-11-4733-2211

Brasil – São Paulo
Phone: +55-11-2103-6000
Fax: +55-11-2103-6030

Chile – Santiago
Phone: +56-2-345-0361
Fax: +56-2-223-1477

Canada – Toronto
Phone: +905-475-6222
Fax: +905-474-5520
Product Information Center:
Phone: +905-470-4425
Fax: +905-474-5525

Colombia – Bogota
Phone: +57-1-319-8959
Fax: +57-1-319-8960

Mexico – Mexico City
Phone: +52-55-1106-0800
+01-800-733-8926
Fax: +52-55-1106-0901

For Latin/South American Countries not shown
Phone: +54-11-4733-2015
Fax: +54-11-4733-2083

United States
Harrisburg, PA
Phone: +1-717-564-0100
Fax: +1-717-986-7575
Product Information Center:
Phone: +1-800-522-6752
Fax: +1-717-986-7575
Troy, MI
Phone: +1-248-273-3359
Fax: +1-248-273-3322

Asia/Pacific

Australia – Sydney
Phone: +61-2-9554-2600
Fax: +61-2-9502-2556
Product Information Center:
Phone: +61-2-9840-8200
Fax: +61-2-9634-6188

India – Bangalore
Phone: +91-80-285-40800
Fax: +91-80-285-40820

Indonesia – Jakarta
Phone: +65-6482-0311
Fax: +65-6482-1012

Japan – Kawasaki, Kanagawa
Phone: +81-44-844-8111
Fax: +81-44-812-3207
Product Information Center:
Phone: +81-44-844-8013
Fax: +81-44-812-3200

Korea – Seoul
Phone: +82-2-3415-4500
Fax: +82-2-3486-3810

Malaysia – Selangor
Phone: +60-3-7805-3055
Fax: +60-3-7805-3066

New Zealand – Auckland
Phone: +64-9-634-4580
Fax: +64-9-634-4586

Philippines – Makati City
Phone: +632-848-0171
Fax: +632-867-8661

People's Republic of China
Hong Kong
Phone: +852-2735-1628
Fax: +852-2735-0243
Shanghai
Phone: +86-21-2407-1588
Fax: +86-21-2407-1599

Singapore – Singapore
Phone: +65-6482-0311
Fax: +65-6482-1012

Taiwan – Taipei
Phone: +886-2-8768-2788
Fax: +886-2-8768-2268

Thailand – Bangkok
Phone: +66-2-955-0500
Fax: +66-2-955-0505

Vietnam – Ho Chi Minh City
Phone: +84-8-930-5546
Fax: +84-8-930-3443

Europe/Middle East/Africa

Austria – Vienna
Phone: +43-1-905-60-0
Fax: +43-1-905-60-1333
Product Information Center:
Phone: +43-1-905-60-1249
Fax: +43-1-905-60-1251

Belarus – Minsk
Phone: +375 17 237 47 94
Fax: +375 17 237 47 94

Belgium – Kessel-Lo
Phone: +32-16-352-300
Fax: +32-16-352-355

Bulgaria – Sofia
Phone: +359-2-971-2152
Fax: +359-2-971-2153

Czech Republic and Slovakia
Czech Republic – Kurim
Phone: +420-541-162-111
Fax: +420-541-162-223
Product Information Center:
Phone: +420-541-162-113
Fax: +420-541-162-132

Denmark – Glostrup
Phone: +45-43-48-04-00
Fax: +45-43-44-14-14

Egypt – Cairo
Phone: +202-419-2334
Fax: +202-417-7647

Estonia – Tartu
Phone: +372-5138-274
Fax: +372-7400-779

Finland – Helsinki
Phone: +358-95-12-34-20
Fax: +358-95-12-34-250

France – Cergy-Pontoise Cedex
Phone: +33-1-3420-8888
Fax: +33-1-3420-8600
Product Information Center:
Phone: +33-1-3420-8686
Fax: +33-1-3420-8623

France Export Divisions –
Cergy-Pontoise Cedex
Phone: +33-1-3420-8804
Fax: +33-1-3420-8699

Germany – Bensheim
Phone: +49-6251-133-0
Fax: +49-6251-133-1600
Product Information Center:
Phone: +49-6251-133-1999
Fax: +49-6251-133-1988

Greece – Athens
Phone: +30-210-9370-396/397
Fax: +30-210-9370-655

Hungary – Budapest
Phone: +36-1-289-1000
Fax: +36-1-289-1010
Product Information Center:
Phone: +36-1-289-1016
Fax: +36-1-289-1017

Ireland – Dublin
Phone: +353-1-866-5612
Fax: +353-1-866-5714

Israel – Petach-Tikva
Phone: +972-3-929-0999
Fax: +972-3-919-1088

Italy – Collegno (Torino)
Phone: +39-011-4012-111
Fax: +39-011-4031-116
Product Information Center:
Phone: +39-011-4012-428
Fax: +39-011-40-287-428

Lithuania and Latvia
Lithuania – Vilnius
Phone: +370-5-213-1402
Fax: +370-5-213-1403
Product Information Center:
Phone: +370-5-211-3016
Fax: +370-5-213-1403

Netherlands – 's-Hertogenbosch
Phone: +31-73-6246-246
Fax: +31-73-6212-365
Product Information Center:
Phone: +31-73-6246-999
Fax: +31-73-6246-998

Norway – Nesbru
Phone: +47-66-77-88-50
Fax: +47-66-77-88-55

Poland – Warsaw
Phone: +48-22-4576-700
Fax: +48-22-4576-720
Product Information Center:
Phone: +48-22-4576-704
Fax: +48-22-4576-720

Romania – Bucharest
Phone: +40-21-311-3479/3596
Fax: +40-21-312-0574

Russia – Moscow
Phone: +7-495-790-7902
Fax: +7-495-721-1893
Product Information Center:
Phone: +7-495-790-7902-404
Fax: +7-495-790-7902-401

Russia – St. Petersburg
Phone: +7-812-718-8192
Fax: +7-812-718-8193

Slovenia – Ljubljana
Phone: +386-1561-3270
Fax: +386-1561-3240

South Africa – Port Elizabeth
Phone: +27-41-503-4500
Fax: +27-41-581-0440

Spain – Barcelona
Phone: +34-93-291-0330
Fax: +34-93-201-7879

Sweden – Upplands Väsby
Phone: +46-8-50-72-50-00
Fax: +46-8-50-72-50-01

Switzerland – Steinach
Phone: +41-71-447-0447
Fax: +41-71-447-0444

Turkey – Istanbul
Phone: +90-212-281-8181/2/3
+90-212-282-5130/5430
Fax: +90-212-281-8184

Ukraine – Kiev
Phone: +380-44-206-2265
Fax: +380-44-206-2264
Product Information Center:
Phone: +380-44-206-2265
Fax: +380-44-206-2264

United Kingdom –
Stanmore, Middlesex
Phone: +44-8706-080208
Fax: +44-208-954-6234
Product Information Center:
Freephone (UK only):
0800-267-666
Phone: +44-8706-080208
Fax: +44-208-420-8095

Tyco Electronics Corporation
Harrisburg, PA

82056-10K-MS-FP-6-08-OG3B

